



The steam catalog

2025-2026



World leading manufacturer of high-quality steam cleaners

Made in Italy

+39 045 67 67 252 | SALES@TECNOVAP.COM | WWW.TECNOVAP.IT



Contacts

Tecnovap S.r.l.

Via dei Sassi 1/a, 37026 Pescantina, Verona - Italy

+39 045 67 67 252 - sales@tecnovap.com - info@tecnovap.com - www.tecnovap.it



SCAN ME!

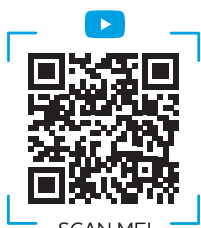

SCAN ME!

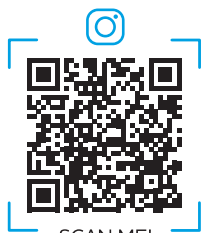

SCAN ME!

Index



Welcome to Tecnovap

- Why choose Tecnovap? 5
- Mission & Vision 6
- Our numbers 7



Why choose steam?

- The power of steam 8
- Where can steam be used? 10



Our technology

- The boiler 16
- MyTecnovap 18
- Technical features 20
- Control panels 22



Products

- Stainless-steel range 25 - 41
- Chattanooga range 43 - 53
- Domestic range 55 - 61
- Bacchus range 63 - 71
- Special models 73 - 79
- Systems for conveyor belts 81 - 91
- Vacuum cleaners 93 - 97
- Tools 99 - 117
- Special tools 119 - 129



Demo pictures

131 - 153

Browsable catalogs



Browse and download our catalogs to discover more regarding the Tecnovap world

Welcome to Tecnovap!

An Italian brand with **40 years of experience** in the steam cleaning sector

The company was founded in 1985 in Negrar di Valpolicella (Verona) as a small family-run artisan business with a clear objective: to produce boilers for steam generators with technologies that were already cutting-edge for that time.

In 2001, after years of growing company development and thanks to the increasingly incessant expansion of the steam cleaning sector, Tecnovap moved its headquarters to Pescantina (Verona), where the company is still located today.

In March 2024, the welding and boiler departments have been moved to a new, additional production headquarter that is adjacent to the main production center.

With **40 years of experience**, the company continues to proceed towards constant improvement of its products and affirms its firm presence not only in the domestic sphere, but also in the professional and industrial sectors.

Thanks to its work and commitment to understand and satisfy customers' needs to the best of its ability, Tecnovap is a leading company in the steam cleaning sector among the domestic and foreign companies it works with.



Giuliano Franchini and Giuseppe Franchini
President & CEO

Why choose Tecnovap?



Italian Quality

Tecnovap entirely follows every stage of the study and design of its products.



Experience and excellence

Leading company in the steam cleaning sector.
Realization of customized projects with ecology-conscious technological solutions.



Research and innovations

Continuous study for the development of new technologies in line with our customers' requirements.



Partnership and trust

The professionalism and mutual support shown over the years have helped us to establish lasting bonds with our customers.



Customer oriented

Close relationships with distributors allow us to offer cleaning solutions that always suit to the needs of operators, as well as innovative and customized accessories.



Technical support

Presence of an extensive network of distributors and specialized centers to guarantee maximum efficiency and prompt intervention in the event of technical support.



Training and professional courses

Thanks to the technical and commercial training courses offered by the company, Tecnovap dealers have all the necessary tools to share the advantages of high-temperature steam cleaning with their customers all over the world.



Our Mission & Values

The leadership in the steam cleaning sector

- Our daily commitment consists in producing the best **Made in Italy** steam cleaners available on the market.
- We value quality not only in the products we sell, but also in the commercial relationships we establish with our customers as well as the technical support we provide our network with: these elements make our steam generators valuable and long-lasting assets.
- We use technologies that are in step with innovation and can satisfy the individual needs of the customers who rely on us.
- We believe in protecting the environment that surrounds us. We develop a cleaning method that has a lower environmental impact than other traditional cleaning techniques.
- We take care of internal and external relationships, basing our bonds on loyalty and reliability.



Our numbers

40 years

Since 1985 by your side, for a cleaner world!



+50

Steam cleaners

Tecnovap offers over 50 models of steam generators for all applications in the domestic, professional and industrial sectors.



+100

Tools

The designing, molding and assembling phases of tools are carried out internally.



+12

Application sectors

Tecnovap steam can be used in many areas, from the Food & Beverage sector to the domestic sphere, thus offering unlimited cleaning possibilities.



+75

Nations around the world

Tecnovap is today present with a strong network of specialized distributors and service centers that guarantee maximum efficiency and reliability.

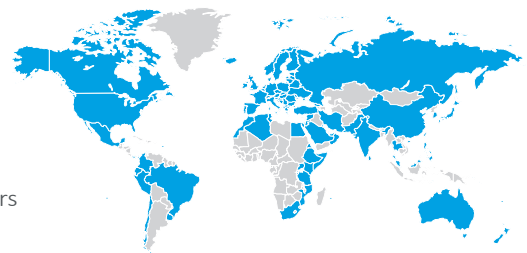

Respect and protect the environment by choosing dry saturated steam



Eco-Friendly

Dry saturated steam cleaning is an environmentally friendly and 100% natural method as it requires only water.



Ideal for uneven surfaces

Thanks to the use of accessories that are designed for specific applications, steam can clean even those interstices that traditional cleaning methods cannot reach, guaranteeing complete and safe cleaning of surfaces.



No contamination

Low pressure steam allows surfaces to be cleaned without contamination of the surrounding ones.



Thermal shock and deep cleaning

Microorganisms present on surfaces cannot develop any immunity to the high temperatures reached by steam. The steam temperature varies from 145°C to 180°C and helps to eliminate bad odours, fungi, mites, germs, and harmful bacteria.



Immediate use

Our steam generators are electric, easy to use and do not require any type of license or qualification.



Cost savings

Steam can be used during the production cycle, avoiding downtime of machinery and production lines. Furthermore, the usage of water and chemicals is drastically reduced.



Save Water!



Industrial sector

Tecnovap has developed more than thirty years of experience in the industrial sector

Our products adapt to the wide spectrum of needs that characterize the highly specific and diversified industrial world.

Steam can be used on any surface, from mechanical industry environments to the external and internal cleaning of public and private means of transport (e.g. trains, ships, planes, etc.).

In the Food & Beverage sector, steam cleaning is valuable and effective, especially for cleaning conveyor belts.



FOOD &
BEVERAGE



MECHANICAL
INDUSTRY



PHARMACEUTICAL
INDUSTRY



CONVEYOR
BELTS



TRANSPORT
INDUSTRY

Healthcare sector

Where steam finds its maximum expression

Hygiene is the essential element in the healthcare sector. Traditional cleaning systems require continuous use of specific chemical products which, however, cannot guarantee a complete disinfection.

Tecnovap offers an ecological, economical, and immediate solution to this need. The use of high temperature steam allows the elimination of microorganisms such as bacteria and viruses.

Tecnovap steam generators are effective for cleaning pharmaceutical laboratories, hospitals, healthcare vehicles, clinics, and medical equipment.



PHARMACEUTICAL
LABORATORIES



HOSPITAL
FACILITIES



FIRST AID
VEHICLES



MEDICAL
SURGERIES

Ho.Re.Ca. & domestic sphere

Tecnovap steam cleaners are the ideal solution for all environments

Steam cleaning reaches its maximum versatility in the HO.RE.CA. sector.

Thanks to steam, hotel rooms and lobbies, upholstery, rugs, and carpets can be quickly cleaned, and even the most stubborn dirt can be removed, eliminating germs and bacteria too.

Steam can be used to clean professional kitchens ensuring a hygienic environment in terms of food safety.

Wellness centers and fitness clubs rely on Tecnovap technology to keep their facilities clean regularly.



RESTAURANTS



HOTELS



SPA & WELLNESS
CENTER



FITNESS &
SPORT CLUBS



HOUSEHOLD

Special applications

Optimal results in every sector

Steam can be used:

- in wineries for the cleaning of barrels, tanks, bottling lines;
- in the car wash sector for cleaning the interiors and exteriors of vehicles;
- to weed public areas, without using glyphosates.

Additionally, steam can be used for cleaning monuments and removing chewing gums.

Wherever there is a need for cleaning, steam is our quick and ecological solution.



WINE
CELLARS



CAR WASH



ECOLOGICAL
WEED KILLING



CHEWING-GUM
REMOVAL



... AND
MUCH MORE!

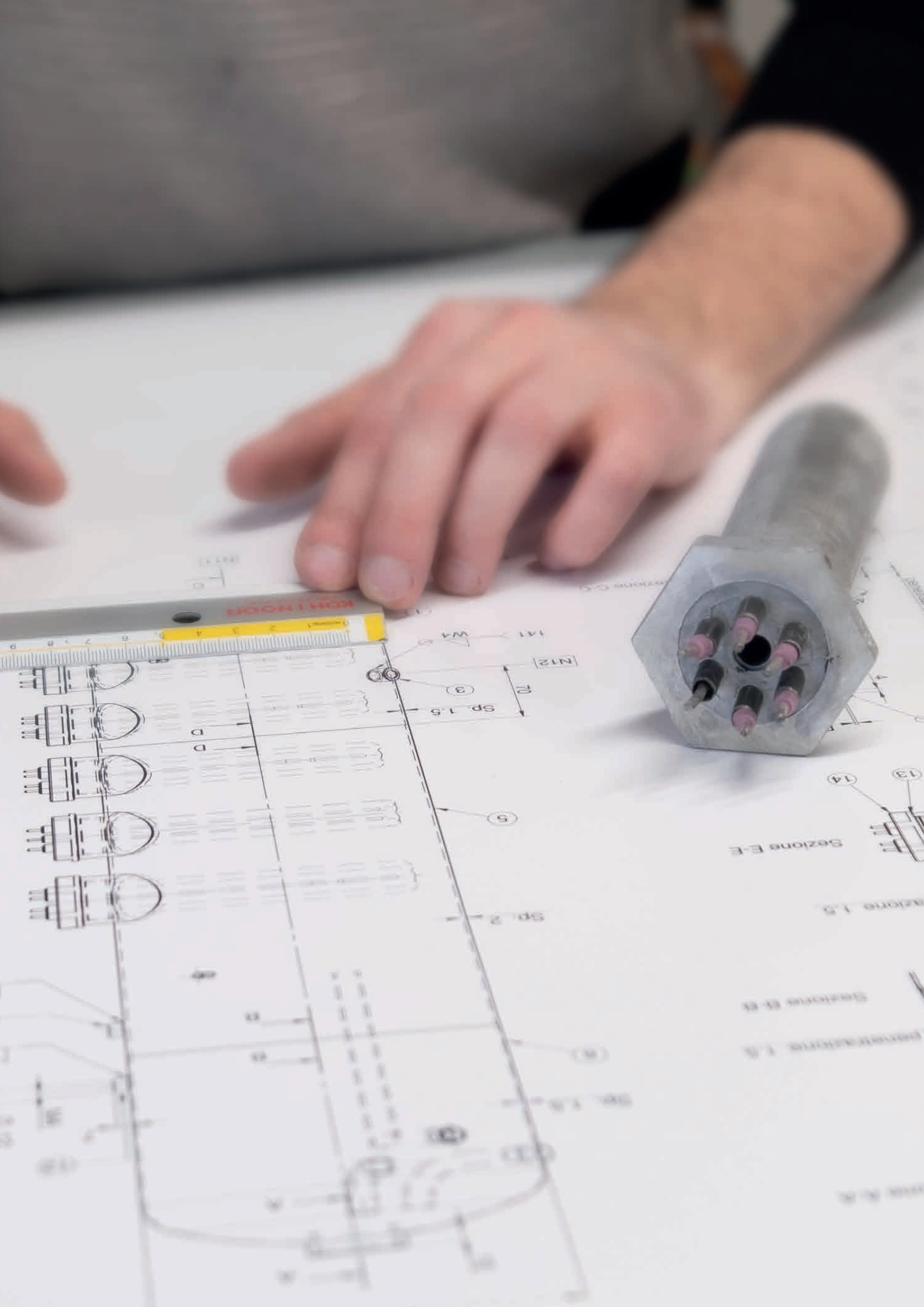

KOHNOR

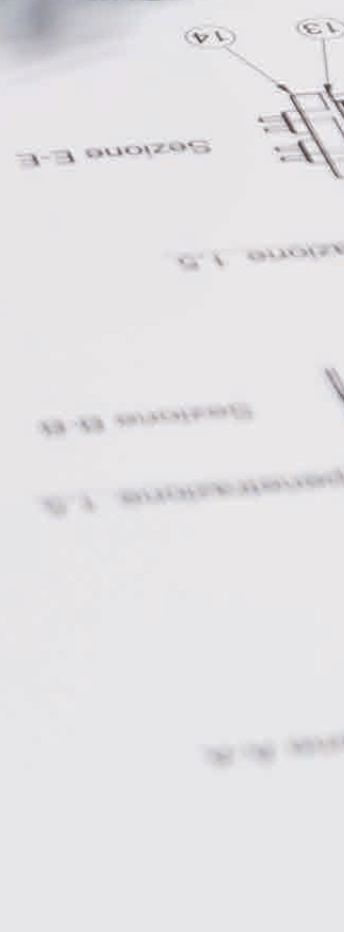
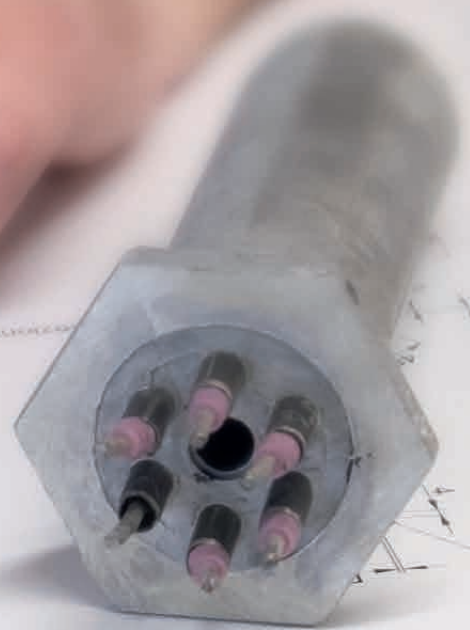
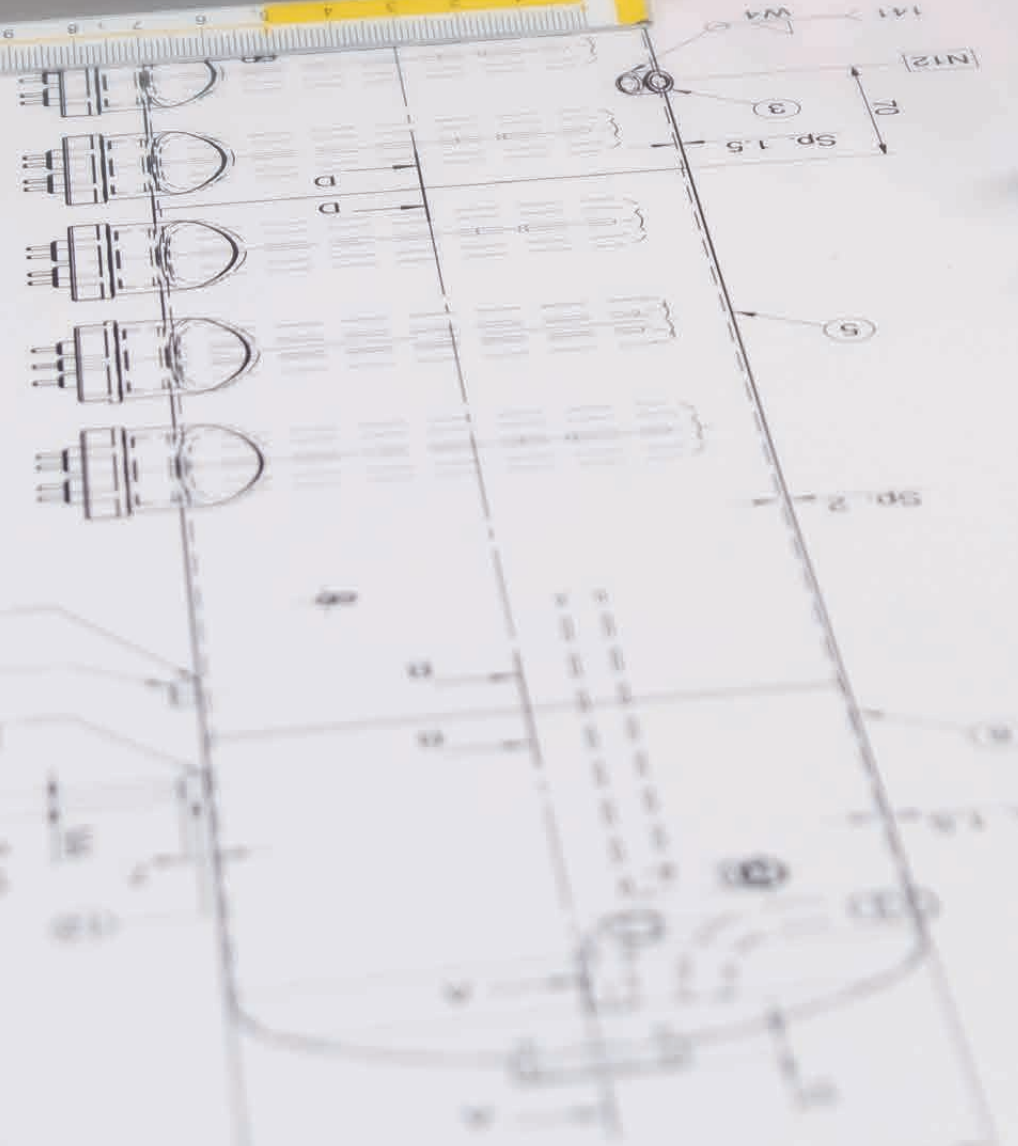

Our technology



The boiler

The heart of our steam cleaners

- Every boiler is manufactured using exclusively AISI 304 or AISI 316 L stainless-steel shells joined with a special "TIG" (Tungsten Inert Gas) welding technique, that is manually performed by our specialized technicians.
- This technique enables to create single-body boilers, without employing any gaskets, which are troublesome components that can wear over time.
- The heating element designed by Tecnovap is able to develop and conduct maximum power in a reduced space.





Types of boiler



Boiler for semi-professional use
from 1,5 to 2,45 kW | 1,5 liters



Boiler for professional use
3,6 kW | 4 liters



Boiler for semi-industrial use
from 7,2 to 14,4 kW | 7 liters



Boiler for industrial use
from 10,8 to 36 kW | from 11 to 13 liters



Available with
ASME certification
for the
U.S. market

MyTecnovap

Your steam cleaner in the palm of your hand!

● MyTecnovap is an app that allows you to connect via Bluetooth to your steam cleaner in real-time!

● Starting from the production of June 2024, the following models:

- Steam Box Mini
- Steam Box Pro
- Steam Box Industrial
- Steam Turbo
- Steam Power

have been equipped with a Bluetooth module which allows you to monitor your steamer via the app.





An example of the steam cleaner diagram

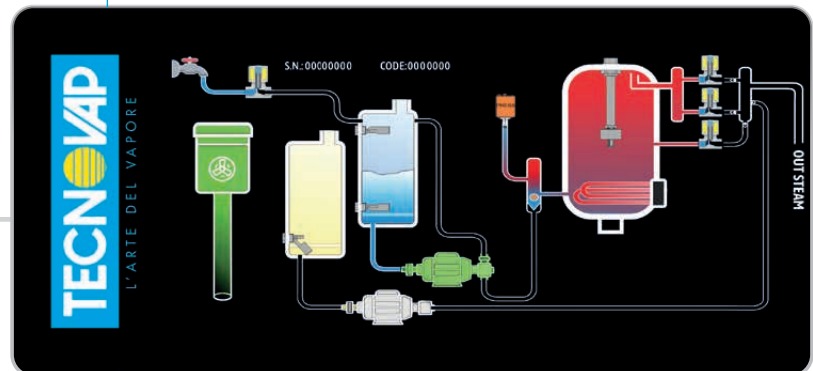

With MyTecnovap you can check:

- **Boiler status:**
Indicates if the boiler is heating up.
- **Steam presence:**
Indicates when the steam is available and the machine is ready for use.
- **Water presence:**
Check in real time the level of the water in the specific tank.
- **Detergent presence:**
Check in real time the level of the detergent in the specific tank.
- **Total counter:**
Indicates the total life hours of the steam cleaner.
- **Partial counter:**
Indicates the operating hours of the steam cleaner.
- **Temperature:**
Indicates in real time the temperature (°C) inside the boiler.
- **Operating pressure:**
Indicates in real time the pressure (bar) inside the boiler.
- **Maintenance timer:**
Indicates the hours remaining until the next steam cleaner ordinary maintenance.
- **Programming:**
It is possible to program the automatic start-up and shutdown of the steam cleaner.
- **Steam cleaner diagram:**
It is possible to see the diagram with the operating circuit of the steam cleaner.



Available on

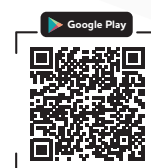

Technical features of our steam cleaners



In our technical data sheets you can find the following pictograms:



Steam operating pressure

Pressure of the steam flow



Water operating pressure

Water pressure from 1 to 150 bar



MyTecnovap connection

You can easily check in real time the status of your steam cleaner from your device via Bluetooth



Automatic water refilling

The water is automatically refilled in the boiler



Control panel

For the management and control of all steam cleaner parameters



Manual boiler refilling

Steam cleaner without an automatic water refill system in the boiler. In order to refill it, wait until the boiler is completely depressurized and cooled down



Water mains connection

By connecting the generator to the water supply, it will not be necessary to refill the tank



Internal water tank*

From 3 to 35 liters of capacity, refillable at any time



Internal detergent tank*

From 1 to 20 liters, refillable at any time

* The tanks uses the heat generated by the boiler to maintain the temperature of the liquids at an optimum level, improving energy efficiency.



Overheated water injection

Possibility of delivering overheated water combined with steam



Detergent injection

Possibility of delivering nebulized detergent combined with steam



Boiler maintenance signal

A CALC message appears on the front panel display when the boiler has to be cleaned



Power regulation switch

The steam cleaner can be equipped with a selector to change the power output (kW)



Steam pressure regulation

Pressure selection from 1 to 10 bar



Water pressure regulation

Pressure regulation from 1 to 150 bar



Detergent flow regulation

Possibility to decrease or increase the detergent flow



Water temperature regulation

Temperature regulation from 20 to 90° C



Diesel-fired boiler

Only for the Steam Sky model



Double steam outlets

For simultaneous use with 2 operators



Wet/dry vacuum cleaner

With water filtration system



Wet/dry vacuum cleaner

With induction turbine



Wet/dry vacuum cleaner

with brush motor



Wet/dry vacuum cleaner

With two brush motors

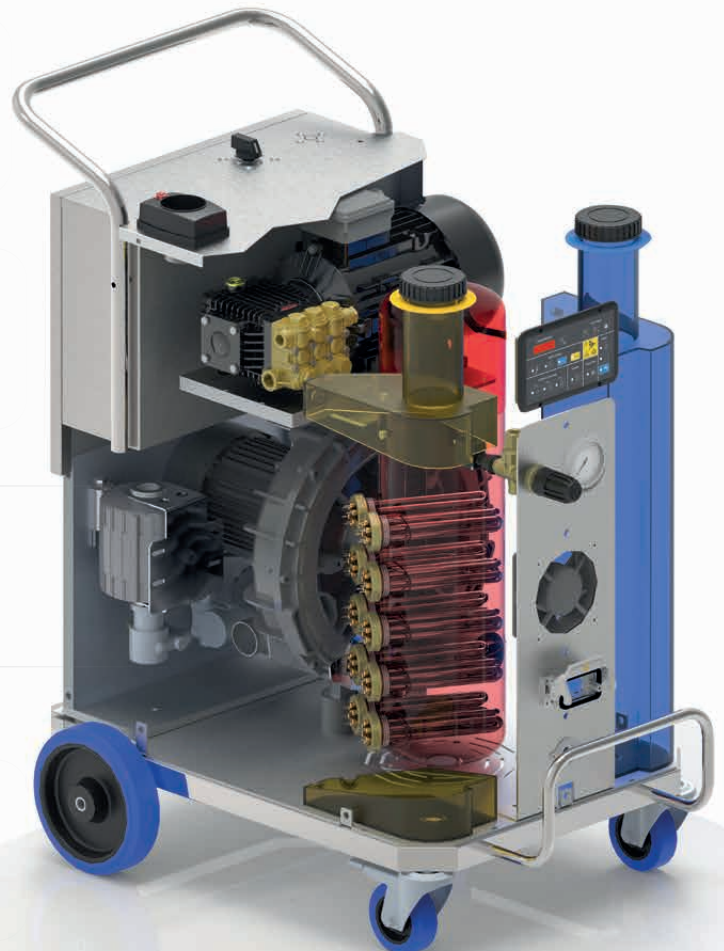

Control panels

The commands on the electronic control panel may vary depending on the model

Equipped on:

- Steam Sky
- Steam Power
- Steam Turbo
- Steam Box models



Equipped on:

- Carmen Plus
- Carmen Plus Inox

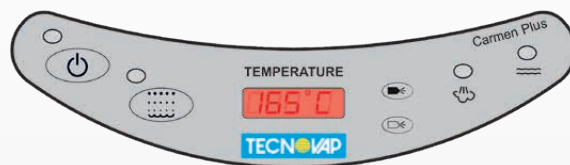

Control panels

The commands on the electronic control panel may vary depending on the model

Equipped on:

- Steam Tech
- Junior Star Max
- Hydrobox
- Gal

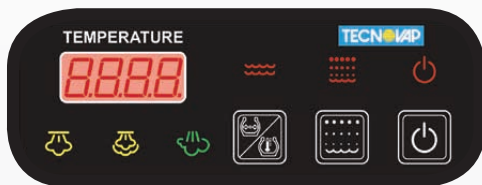

Equipped on:

- Evo 304
- Evo Blu
- Evo Sanitizer





STEAM CLEANERS

Stainless-steel range

Stainless-steel



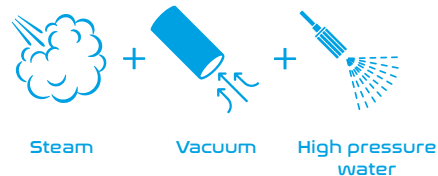

Steam Power Plus

kW 17,8 18,4 21 21,6 35,8 39,4

Steam cleaner with stainless-steel body and boiler, designed for industrial use and able to deliver dry saturated steam at 183° C and high-pressure water up to 150 bar:

- Equipped with a wet/dry vacuum cleaner with an induction turbine and drainage hose.
- A sturdy structure, a fully electric operation and the compact size allows its a usage in any environment, both outdoors (watertight protection IPX5) and indoors (e.g. in production lines).
- All steam cleaner functions can be managed on the electronic control panel.
- Equipped with accessories basket, double hose holder, lance holder, cable holder and front 360° swivel wheels with safety brakes.

Applications



Steam cleaner

Boiler	Stainless-steel AISI 304 with interchangeable heating elements						
Body	Stainless-steel AISI 304 BA						
Power supply	V - Hz	3~ 400 - 50 (60Hz on request)					
Boiler output	kW/h	10,8	14,4	18	21,6	28,8	36
Maximum output	kW/h	17,8	18,4	21	21,6	35,8	39,4
Boiler volume	l	13					
Operating pressure	bar	from 1 to 10					
Water tank	l	14					
Detergent tank	l	14					
Steam production	g/min	291	388	485	582	776	970
	Kg/h	17,5	23	29,1	35	46,5	58
Steam temperature	° C	165 - 183					

High pressure water module

Motor output	kW/h	4
Water flow	l/min	13
Operating pressure	bar	from 0 to 150

Vacuum cleaner

Power output	kW/h	3	
Drum material	-	Stainless-steel AISI 304	
Drum capacity	l	14	43
Air flow	m3/h	320	
Depression	mm	3200	

Various

Weight	Kg	180
Cable	m	8
Dimensions accessory holders included	cm	H.166 x L.69 x W. 101,6
Pallet dimensions	cm	120x80x165
Pallet/unit	pcs	1

Technical features

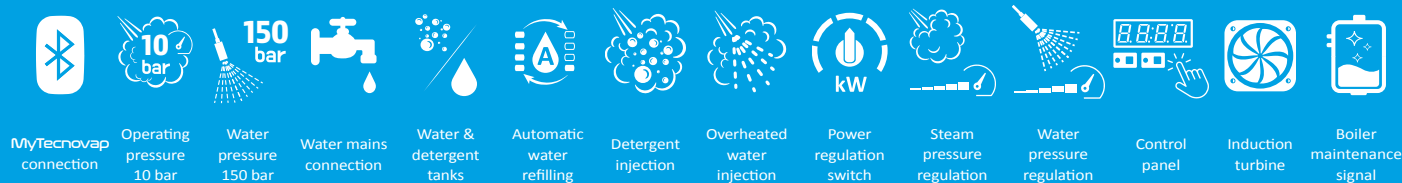



Steam



High pressure water

Steam cleaners



Steam Power

kW 14,8 18,4 21,2 21,6 32,8 40

Applications



Food & Beverage



Mechanical industry



Health care



Transport industry



Special applications

Steam cleaner with stainless-steel body and boiler, designed for industrial use and able to deliver dry saturated steam at 183° C and high-pressure water up to 150 bar:

- A sturdy structure, a fully electric operation and the compact size allows its usage in any environment, both outdoors (watertight protection IPX5) and indoors (e.g. in production lines).
- All steam cleaner functions can be managed on the electronic control panel.
- Equipped with accessories basket, double hose holder, lance holder, cable holder and front 360° swivel wheels with safety brakes.

Steam cleaner

Boiler	Stainless-steel AISI 304 with interchangeable heating elements						
Body	Stainless-steel AISI 304 BA						
Power supply	V - Hz	3~ 400 - 50 (60Hz on request)					
Boiler output	kW/h	10,8	14,4	18	21,6	28,8	36
Maximum output	kW/h	14,8	18,4	21,2	21,6	32,8	40
Boiler volume	l	13					
Operating pressure	bar	from 1 to 10					
Water tank	l	14					
Detergent tank	l	14					
Steam production	g/min	291	388	485	582	776	970
	Kg/h	17,5	23	29,1	35	46,5	58
Steam temperature	° C	165 - 183					

High pressure water module

Motor output	kW/h	4
Water flow	l/min	13
Operating pressure	bar	from 0 to 150

Various

Weight	Kg	141
Cable	m	8
Dimensions accessory holders included	cm	H.102 x L.69 x W. 101,6
Pallet dimensions	cm	120x80x130
Pallet/unit	pcs	1



Stainless-steel

Technical features



MyTecnovap connection



Operating pressure 10 bar



Water pressure 150 bar



Water mains connection



Water & detergent tanks



Automatic water refilling



Detergent injection



Overheated water injection



Power regulation switch



Water pressure regulation



Steam pressure regulation



Control panel



Boiler maintenance signal



Steam



Vacuum

Steam Turbo

kW 10,8 17,4 21 21,6 31,8 39

Steam cleaner with stainless-steel body and boiler, designed for industrial use and able to deliver dry saturated steam at 183° C:

- Equipped with a wet/dry vacuum cleaner with an induction turbine and drainage hose.
- A sturdy structure, a fully electric operation and the compact size allows its a usage in any environment, both outdoors (watertight protection IPX5) and indoors (e.g. in production lines).
- All steam cleaner functions can be managed on the electronic control panel.
- Equipped with accessories basket, double hose holder, lance holder, cable holder and front 360° swivel wheels with safety brakes.

Applications



Food & Beverage



Mechanical industry



Conveyor belts



Transport industry



Special applications



Steam cleaner

Boiler	Stainless-steel AISI 304 with interchangeable heating elements						
Body	Stainless-steel AISI 304 BA						
Power supply	V - Hz	3~ 400 - 50 (60Hz on request)					
Boiler output	kW/h	10,8	14,4	18	21,6	28,8	36
Maximum output	kW/h	10,8	17,4	21	21,6	31,8	39
Boiler volume	l	13					
Operating pressure	bar	from 1 to 10					
Water tank	l	14					
Detergent tank	l	14					
Steam production	g/min	291	388	485	582	776	970
	Kg/h	17,5	23	29,1	35	46,5	58
Steam temperature	° C	165 - 183					

Vacuum cleaner

Power output	kW/h	3	
Drum material	-	Stainless-steel AISI 304	
Drum capacity	l	14	43
Air flow	m3/h	320	
Depression	mm	3200	

Various

Weight	Kg	151
Cable	m	8
Dimensions <i>accessory holders included</i>	cm	H.166 x L.69 x W. 101,6
Pallet dimensions	cm	120x80x165
Pallet/unit	pcs	1

Technical features



MyTecnovap connection



Operating pressure 10 bar



Water mains connection



Water tank



Detergent tank



Automatic water refilling



Detergent injection



Overheated water injection



Power regulation switch



Water pressure regulation



Induction turbine



Control panel



Boiler maintenance signal



Steam



Vacuum

Steam cleaners



Steam Box Vac Industrial

kW 11 17,8 21,8 31,4 38,6

Applications



Food & Beverage



Mechanical industry



Health care



Transport industry



Conveyor belts



Special applications

Steam cleaner with stainless-steel body and boiler, designed for industrial use and able to deliver dry saturated steam at 183° C:

- Equipped with a wet/dry vacuum cleaner with two brush motors and drum with drainage hose.
- A sturdy structure, a fully electric operation and the compact size allows its usage in any environment, both outdoors (watertight protection IPX5) and indoors (e.g. in production lines).
- All steam cleaner functions can be managed on the electronic control panel.
- Equipped with hose holder, cable holder and front 360° swivel wheels with safety brakes.

Stainless-steel

Steam cleaner

Boiler	Stainless-steel AISI 304 with interchangeable heating elements					
Body	Stainless-steel AISI 304 BA					
Power supply	V - Hz	3~ 400 - 50/60				
Boiler output	kW/h	10,8	14,4	21,6	28,8	36
Maximum output	kW/h	11	17,8	21,8	31,4	38,6
Boiler volume	l	11	12	13		
Operating pressure	bar	10				
Water tank	l	20				
Detergent tank	l	20				
Steam production	g/min	291	388	582	776	970
	Kg/h	17,5	23	35	46,5	58
Steam temperature	° C	183				

Vacuum cleaner

Power output	kW/h	2,4
Drum material	-	Stainless-steel AISI 304
Drum capacity	l	25
Air flow	m3/h	320
Depression	mm	3200

Various

Weight	Kg	113
Cable	m	8
Dimensions accessory holders included	cm	H.161,8 x L.53,3 x W. 83
Pallet dimensions	cm	115x65x125
Pallet/unit	pcs	1



Technical features



MyTecnovap connection



Operating pressure 10 bar



Water mains connection



Water tank



Detergent tank



Power regulation switch



Automatic water refilling



Detergent injection



Overheated water injection



Vacuum cleaner w/2 motors



Control panel



Boiler maintenance signal



Steam



Vacuum

Steam Box Vac Industrial

kW 11,1 15,8 22,15

Steam cleaner with stainless-steel body and boiler, designed for industrial use and able to deliver dry saturated steam at 183° C:

- Equipped with a wet/dry vacuum cleaner with an induction turbine.
- A sturdy structure, a fully electric operation and the compact size allows its a usage in any environment, both outdoors (watertight protection IPX5) and indoors (e.g. in production lines).
- All steam cleaner functions can be managed on the electronic control panel.
- Equipped with accessories basket, hose holder, cable holder and front 360° swivel wheels with safety brakes.

Applications



Stainless-steel



Steam cleaner

Boiler	Stainless-steel AISI 304 with interchangeable heating elements		
Body	Stainless-steel AISI 304 BA		
Power supply	V - Hz	3~ 400 - 50/60	
Boiler output	kW/h	10	14,4 20,75
Maximum output	kW/h	11,1	15,8 22,15
Boiler volume	l	11	12
Operating pressure	bar	10	
Water tank	l	20	
Detergent tank	l	20	
Steam production	g/min	291	388 564
	Kg/h	17,5	23 33,8
Steam temperature	° C	183	

Vacuum cleaner

Power output	kW/h	1
Drum material	-	Stainless-steel AISI 304
Drum capacity	l	7,5 14
Air flow	m3/h	200
Depression	mm	2200

Various

Weight	Kg	113
Cable	m	8
Dimensions accessory holders included	cm	H.131,1 x L.53,3 x W. 82,6
Pallet dimensions	cm	115x65x125
Pallet/unit	pcs	1

Technical features



MyTecnovap connection



Operating pressure 10 bar



Water mains connection



Water tank



Detergent tank



Power regulation switch



Automatic water refilling



Detergent injection



Overheated water injection



Induction turbine



Control panel



Boiler maintenance signal



Steam

Steam Box Industrial

kW 11 17,8 21,8 29 36,2

Applications



Food & Beverage



Mechanical industry



Health care



Transport industry



Special applications

Steam cleaner with stainless-steel body and boiler, designed for industrial use and able to deliver dry saturated steam at 183° C:

- A sturdy structure, a fully electric operation and the compact size allows its usage in any environment, both outdoors (watertight protection IPX5) and indoors (e.g. in production lines).
- All steam cleaner functions can be managed on the electronic control panel.
- Equipped with accessories basket, hose holder, cable holder and front 360° swivel wheels with safety brakes.

Stainless-steel

Steam cleaner

Boiler	Stainless-steel AISI 304 with interchangeable heating elements					
Body	Stainless-steel AISI 304 BA					
Power supply	V - Hz	3~ 400 - 50/60				
Boiler output	kW/h	10,8	14,4	21,6	28,8	36
Maximum output	kW/h	11	14,6	21,8	29	36,2
Boiler volume	l	11	12	13		
Operating pressure	bar	10				
Water tank	l	20				
Detergent tank	l	20				
Steam production	g/min	291	388	582	776	970
	Kg/h	17,5	23	35	46,5	58
Steam temperature	° C	183				

Various

Weight	Kg	96 (mod.36kW)
Cable	m	8
Dimensions accessory holders included	cm	H.110 x L.53,3 x W. 82,6
Pallet dimensions	cm	115x65x125
Pallet/unit	pcs	1



Technical features



MyTecnovap connection



Operating pressure 10 bar



Water mains connection



Water tank



Detergent tank



Power regulation switch



Automatic water refilling



Detergent injection



Overheated water injection



Control panel



Boiler maintenance signal



Steam



Vacuum

Steam Box Vac Pro

kW 8,4 — 11,1 — 15,6

Steam cleaner with stainless-steel body and boiler, designed for industrial use and able to deliver dry saturated steam at 183° C:

- Equipped with a wet/dry vacuum cleaner with an induction turbine or brush motor.
- A sturdy structure, a fully electric operation and the compact size allows its usage in any environment, both outdoors (watertight protection IPX5) and indoors (e.g. in production lines).
- All steam cleaner functions can be managed on the electronic control panel.
- Equipped with accessories basket, hose holder, cable holder and front 360° swivel wheels with safety brakes.

Applications



Food & Beverage



Mechanical industry



Health care



Transport industry



Conveyor belts



Car wash

Version with vacuum cleaner with brush motor



Steam cleaner

Boiler	Stainless-steel AISI 304 with interchangeable heating elements			
Body	Stainless-steel AISI 304 BA			
Power supply	V - Hz	3~ 400 - 50/60		
Boiler output	kW/h	7,2	10	14,4
Maximum output	kW/h	8,4	11,1	15,6
Boiler volume	l	7		
Operating pressure	bar	10		
Water tank	l	14		
Detergent tank	l	14		
Steam production	g/min	194	272	388
	Kg/h	11,6	16,3	23
Steam temperature	° C	183		

Vacuum cleaner (with induction turbine)

Power output	kW/h	1	
Drum material	-	Stainless-steel AISI 304	
Drum capacity	l	7,5	14
Air flow	m3/h	200	
Depression	mm	2200	

Various

Weight	Kg	82
Cable	m	8
Dimensions <i>accessory holders included</i>	cm	H.124,1 x L.53,1 x W. 82,5
Pallet dimensions	cm	115x65x125
Pallet/unit	pcs	1

Technical features



MyTecnovap connection



Operating pressure 10 bar



Water mains connection



Water tank



Detergent tank



Automatic water refilling



Power regulation switch



Detergent injection



Overheated water injection



Induction turbine



Control panel



Boiler maintenance signal



Steam

Steam Box Pro

kW 7,35 10,95 14,55

Applications



Food & Beverage



Mechanical industry



Health care



Transport industry



Special applications

Steam cleaner with stainless-steel body and boiler, designed for industrial use and able to deliver dry saturated steam at 183° C:

- A sturdy structure, a fully electric operation and the compact size allows its usage in any environment, both outdoors (watertight protection IPX5) and indoors (e.g. in production lines).
- All steam cleaner functions can be managed on the electronic control panel.
- Equipped with accessories basket, hose/cable holder and front 360° swivel wheels with safety brakes.

Stainless-steel

Steam cleaner

Boiler	Stainless-steel AISI 304 with interchangeable heating elements			
Body	Stainless-steel AISI 304 BA			
Power supply	V - Hz	3~ 400 - 50/60		
Boiler output	kW/h	7,2	10,8	14,4
Maximum output	kW/h	7,35	10,95	14,55
Boiler volume	l	7		
Operating pressure	bar	10		
Water tank	l	14		
Detergent tank	l	14		
Steam production	g/min	194	272	388
	Kg/h	11,6	16,3	23
Steam temperature	° C	183		

Various

Weight	Kg	60
Cable	m	8
Dimensions <i>accessory holders included</i>	cm	H.110,3 x L.53,1 x W. 82,5
Pallet dimensions	cm	115x65x125
Pallet/unit	pcs	1



Technical features



MyTecnovap connection



Operating pressure 10 bar



Water mains connection



Water tank



Detergent tank



Power regulation switch



Automatic water refilling



Detergent injection



Overheated water injection



Control panel



Boiler maintenance signal



Steam



Vacuum

Steam Box Vac Mini

kW 3,75

Steam cleaner with stainless-steel body and boiler, designed for professional use and able to deliver dry saturated steam at 165°C, 174°C or 183°C:

- Equipped with a wet/dry vacuum cleaner.
- A sturdy structure, a fully electric operation and the compact size allows its usage in any environment, both outdoors (watertight protection IPX5) and indoors (e.g. in production lines).
- All steam cleaner functions can be managed on the electronic control panel.
- Equipped with hose holder, double accessories basket, cable holder, extension tube holders and front 360° swivel wheels.

Applications



Ho.Re.Ca.



Health care



Special applications



Transport industry



Car wash



Steam cleaner

Boiler	Stainless-steel AISI 304 with interchangeable heating element		
Body	Stainless-steel AISI 304 BA		
Power supply	V - Hz	1~ 230 - 50/60 3~ 400 - 50/60	
Boiler output	kW/h	3,6	
Maximum output	kW/h	3,75	
Boiler volume	l	5	
Operating pressure	bar	6	8 10
Water tank	l	7,5	
Detergent tank	l	7,5	
Steam production	g/min	97	
	Kg/h	5,9	
Steam temperature	° C	165	174 183

Vacuum cleaner

Power output	kW/h	1,2	
Drum material	-	Plastic	Stainless-steel
Drum capacity	l	5,5	7,5
Air flow	m3/h	200	
Depression	mm	2200	

Various

Weight	Kg	35	
Cable	m	8	
Dimensions <i>accessory holders included</i>	cm	H.105,6 x L.41,3 x W. 66	
Packaging	cm	50x40x80	
Pallet/unit	pcs	4	8

Technical features



MyTecnovap connection



Operating pressure 6bar



Operating pressure 8 bar



Operating pressure 10 bar



Water mains connection



Water tank



Detergent tank



Automatic water refilling



Detergent injection



Overheated water injection



Vacuum cleaner



Control panel



Boiler maintenance signal



Steam Box Mini

kW 3,75

Applications



Ho.Re.Ca.



Health care



Special applications

Steam cleaner with stainless-steel body and boiler, designed for professional use and able to deliver dry saturated steam at 165°C, 174°C or 183°C:

- A sturdy structure, a fully electric operation and the compact size allows its usage in any environment, both outdoors (watertight protection IPX5) and indoors (e.g. in production lines).
- All steam cleaner functions can be managed on the electronic control panel.
- Equipped with hose holder, double accessories basket, cable holder, extension tube holders and front 360° swivel wheels.

Stainless-steel

Steam cleaner

Boiler	Stainless-steel AISI 304 with interchangeable heating element		
Body	Stainless-steel AISI 304 BA		
Power supply	V - Hz	1~ 230 - 50/60 3~ 400 - 50/60	
Boiler output	kW/h	3,6	
Maximum output	kW/h	3,75	
Boiler volume	l	5	
Operating pressure	bar	6	8 10
Water tank	l	7,5	
Detergent tank	l	7,5	
Steam production	g/min	97	
	Kg/h	5,9	
Steam temperature	° C	165	174 183

Various

Weight	Kg	30	
Cable	m	8	
Dimensions <i>accessory holders included</i>	cm	H.99 x L.41,3 x W. 66	
Packaging	cm	50x40x80	
Pallet/unit	pcs	4	8



Technical features



MyTecnovap connection



Operating pressure 6bar



Operating pressure 8 bar



Operating pressure 10 bar



Water mains connection



Water tank



Detergent tank



Automatic water refilling



Detergent injection



Overheated water injection



Control panel



Boiler maintenance signal



Steam



Vacuum

Carmen Plus Inox

kW 3,75

Steam cleaner with stainless-steel body and boiler, designed for professional use and able to deliver dry saturated steam at 165°C:

- Equipped with a wet&dry vacuum cleaner with a float that controls its operation..
- The ergonomic structure, the fully electric operation and the compact size allows its to usage in any environment.
- All steam cleaner functions can be managed on the electronic control panel.
- Equipped with hose holder, extension tubes holder, double accessories basket, cable holder, support bracket for Steam Mop and 360° swivel front wheels.

Applications



Ho.Re.Ca.



Health care



Car wash



Special applications



Steam cleaner

Boiler	Stainless-steel AISI 304 with interchangeable heating element	
Body	Stainless-steel AISI 304 BA	
Power supply	V - Hz	1~ 230 - 50/60
Boiler output	kW/h	3,6
Maximum output	kW/h	3,75
Boiler volume	l	4
Operating pressure	bar	6
Water tank	l	3
Detergent tank	l	3
Steam production	g/min	97
	Kg/h	5,9
Steam temperature	° C	165

Vacuum cleaner

Power output	kW/h	1,2	
Drum material	-	Plastic	Stainless-steel
Drum capacity	l	5,5	7,5
Air flow	m3/h	200	
Depression	mm	2200	

Various

Weight	Kg	33	
Cable	m	8	
Dimensions	cm	H.99 x L.40,8 x W. 69,7	
Packaging	cm	60x45x75	
Pallet/unit	pcs	4	8

Technical features



Operating pressure
6bar



Water tank



Detergent tank



Automatic water refilling



Power regulation switch



Detergent injection



Detergent regulation



Overheated water injection



Control panel



Vacuum



Boiler maintenance signal



Steam



Vacuum

Carmen Mini Inox

kW 2,45

Applications



Health care

Ho.Re.Ca.



Household

Steam cleaner with stainless-steel boiler, designed for semi-professional use and able to deliver dry saturated steam 165°:

- Equipped with a wet&dry vacuum cleaner and a water filtration system.
- The ergonomic structure, the fully electric operation and the compact size allows its usage in any environment.
- Equipped with hose holder, extension tubes holder, double accessories basket, cable holder, support bracket for Steam Mop and 360° swivel front wheels.

Steam cleaner

Boiler	Stainless-steel AISI 304 with interchangeable heating element	
Body	Upper: Stainless-steel AISI 304 BA Lower: Varnished steel	
Power supply	V - Hz	1~ 230 - 50/60
Boiler output	kW/h	2,4
Maximum output	kW/h	2,45
Boiler volume	l	1,5
Operating pressure	bar	6
Water tank	l	2,5
Steam production	g/min	64
	Kg/h	3,8
Steam temperature	° C	165

Vacuum cleaner

Power output	kW/h	1,2
Drum material	-	Stainless-steel
Drum capacity	l	7,5
Air flow	m3/h	200
Depression	mm	2200

Various

Weight	Kg	22
Cable	m	5
Dimensions	cm	H.99 x L.40,8 x W. 69,7
Packaging	cm	50x40x80
Pallet/unit	pcs	8



Stainless-steel

Technical features



Operating pressure
6 bar



Water
tank



Overheated
water injection



Automatic
water refilling



Vacuum



Steam

Evo 304 Det

kW 2,45

Steam cleaner designed for professional use with stainless-steel body and boiler able to deliver dry saturated steam 174°C:

- Detergent injection.
- The ergonomic structure, the fully electric operation and the small size allows its to usage in any environment.
- All steam cleaner functions can be managed on the electronic control panel.
- Equipped with rubber bumper, cable holder and anti-scratch 360° swivel front wheels.

Applications

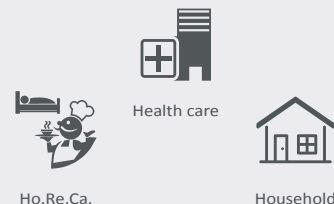

Stainless-steel



Steam cleaner

Boiler	Stainless-steel AISI 304 with interchangeable heating element	
Body	Stainless-steel AISI 304 BA	
Power supply	V - Hz	1~ 230 - 50/60
Boiler output	kW/h	2,4
Maximum output	kW/h	2,45
Boiler volume	l	1,5
Operating pressure	bar	8
Water tank	l	3
Detergent tank	l	1
Steam production	g/min	64
	Kg/h	3,8
Steam temperature	°C	174

Various

Weight	Kg	16
Cable	m	5
Dimensions	cm	H.32,8 x L.28,9 x W. 43,8
Packaging	cm	53 x 40 x 52
Pallet/unit	pcs	24

Technical features



Operating pressure 8 bar



Water tank



Detergent tank



Automatic water refilling



Detergent injection



Control panel



Boiler maintenance signal



Evo 304 Water

kW 2,45

Applications



Steam cleaner designed for professional use with stainless-steel body and boiler able to deliver dry saturated steam 174°C:

- Overheated water injection.
- The ergonomic structure, the fully electric operation and the small size allows its usage in any environment.
- All steam cleaner functions can be managed on the electronic control panel.
- Equipped with rubber bumper, cable holder and anti-scratch 360° swivel front wheels.

Steam cleaner

Boiler	Stainless-steel AISI 304 with interchangeable heating element	
Body	Stainless-steel AISI 304 BA	
Power supply	V - Hz	1~ 230 - 50/60
Boiler output	kW/h	2,4
Maximum output	kW/h	2,45
Boiler volume	l	1,5
Operating pressure	bar	8
Water tank	l	3
Steam production	g/min	64
	Kg/h	3,8
Steam temperature	° C	174

Various

Weight	Kg	16
Cable	m	5
Dimensions	cm	H.32,8 x L.28,9 x W. 43,8
Packaging	cm	53 x 40 x 52
Pallet/unit	pcs	24



Stainless-steel

Technical features



Operating pressure 8 bar



Water tank



Automatic water refilling



Overheated water injection



Control panel



Boiler maintenance signal



Steam

Evo 304 24/7

kW 2,45

Steam cleaner designed for professional use with stainless-steel body and boiler able to deliver dry saturated steam 174°C:

- The ergonomic structure, the fully electric operation and the small size allows its to usage in any environment. a
- All steam cleaner functions can be managed on the electronic control panel.
- Equipped with rubber bumper, cable holder and anti-scratch 360° swivel front wheels.

Applications

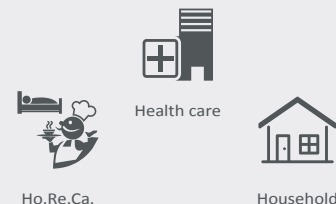

Steam cleaner

Boiler	Stainless-steel AISI 304 with interchangeable heating element	
Body	Stainless-steel AISI 304 BA	
Power supply	V - Hz	1~ 230 - 50/60
Boiler output	kW/h	2,4
Maximum output	kW/h	2,45
Boiler volume	l	1,5
Operating pressure	bar	8
Water tank	l	3
Steam production	g/min	64
	Kg/h	3,8
Steam temperature	° C	174

Various

Weight	Kg	16
Cable	m	5
Dimensions	cm	H.32,8 x L.28,9 x W. 43,8
Packaging	cm	53 x 40 x 52
Pallet/unit	pcs	24

Technical features



Operating pressure
8 bar



Water tank



Automatic
water refilling



Control
panel



Boiler
maintenance
signal



Evo 304 Base

kW 2,4

Applications



Steam cleaner designed for semi-professional use with stainless-steel body and boiler able to deliver dry saturated steam 165°C:

- The ergonomic structure, the fully electric operation and the small size allows its to usage in any environment.
- All steam cleaner functions can be managed on the electronic control panel.
- Equipped with rubber bumper, cable holder and anti-scratch 360° swivel front wheels.

Stainless-steel

Steam cleaner

Boiler	Stainless-steel AISI 304 with interchangeable heating element	
Body	Stainless-steel AISI 304 BA	
Power supply	V - Hz	1~ 230 - 50/60
Boiler output	kW/h	2,4
Maximum output	kW/h	2,4
Boiler volume	l	4
Operating pressure	bar	6
Water capacity	l	3
Steam production	g/min	64
	Kg/h	3,8
Steam temperature	° C	165

Various

Weight	Kg	14
Cable	m	5
Dimensions	cm	H.32,8 x L.28,9 x W. 43,8
Packaging	cm	53 x 40 x 52
Pallet/unit	pcs	24



Technical features



Operating pressure
6 bar



Manual
boiler refilling



Control
panel



Boiler
maintenance
signal



STEAM CLEANERS

Chattanooga range

Chattanooga





Steam



Vacuum

Steam Tech

kW 3,75 8,5 12,1 15,6

Steam cleaner designed for industrial use with stainless-steel boiler and polyethylene body able to deliver dry saturated steam 165°C or 183°C:

- Equipped with a wet&dry vacuum cleaner, a float that controls its operation.
- The sturdy structure, the fully electric operation and the compact size allows its to usage in any environment.
- All steam cleaner functions can be managed on the electronic control panel.
- Equipped with hose/cable holder, accessories basket and 360° swivel front wheels.

Applications



Food & Beverage



Mechanical industry



Transport industry



Car wash



Special applications

Chattanooga



Steam cleaner

Boiler	Stainless-steel AISI 304 with interchangeable heating elements				
Body	PE - Varnished steel				
Power supply	V - Hz	1~ 230 - 50/60		3~ 400 - 50/60	
Boiler output	kW/h	3,6	7,2	10,8	14,4
Maximum output	kW/h	3,75	8,5	12,1	15,6
Boiler volume	l	7			
Operating pressure	bar	6	10		
Water tank	l	15			
Detergent tank	l	15			
Steam production	g/min	97	194	291	388
	Kg/h	5,9	11,6	17,5	23
Steam temperature	° C	165	183		

Vacuum cleaner

Power output	kW/h	1,2
Drum material	-	Plastic
Drum capacity	l	14
Air flow	m3/h	200
Depression	mm	2200

Various

Weight	Kg	56
Cable	m	8
Dimensions	cm	H.86 x L.54 x W. 100
Pallet dimensions	cm	113x58x86
Pallet/unit	pcs	1

Technical features



Operating pressure
6bar



Operating pressure
10 bar



Water tank



Detergent tank



Automatic water refilling



Detergent injection



Overheated water injection



Control panel



Vacuum



Boiler maintenance signal



Steam

+



Vacuum

Steam cleaners



Junior Star Max

kW 3,65

Applications



Steam cleaner designed for professional use with stainless-steel boiler and polyethylene body, able to deliver dry saturated steam 174°C or 165°C:

- Equipped with a wet&dry vacuum cleaner, a float that controls its operation.
- The ergonomic structure, the fully electric operation and the compact size allows its usage in any environment.
- All steam cleaner functions can be managed on the electronic control panel.
- Equipped with hose holder, cable holder, double accessories basket and 360° swivel front wheels.

Steam cleaner

Boiler	Stainless-steel AISI 304 with interchangeable heating element	
Body	PE - Varnished steel	
Power supply	V - Hz	1~ 230 - 50/60
Boiler output	kW/h	3,6
Maximum output	kW/h	3,65
Boiler volume	l	5
Operating pressure	bar	6 8
Water tank	l	4
Detergent tank	l	2
Steam production	g/min	97
	Kg/h	5,9
Steam temperature	°C	165 174

Vacuum cleaner

Power output	kW/h	1,2
Drum material	-	Plastic
Drum capacity	l	14
Air flow	m3/h	200
Depression	mm	2200

Various

Weight	Kg	45
Cable	m	8
Dimensions	cm	H.86 x L.54 x W. 100
Packaging	cm	73x48x63
Pallet/unit	pcs	4



Chattanooga

Technical features



Operating pressure
6bar



Operating pressure
8 bar



Water tank



Detergent tank



Automatic water refilling



Detergent injection



Overheated water injection



Control panel



Vacuum cleaner



Boiler maintenance signal



Steam



Vacuum

Carmen Plus

kW **3,65**

Steam cleaner designed for professional use with varnished-steel body and stainless-steel boiler able to deliver dry saturated steam at 165°C:

- Equipped with a wet&dry vacuum cleaner with a float that controls its operation.
- The ergonomic structure, the fully electric operation and the compact size allows its to usage in any environment.
- All steam cleaner functions can be managed on the electronic control panel.
- Equipped with hose holder, extension tubes holder, double accessories basket, cable holder, support bracket for Steam Mop and 360° swivel front wheels.

Applications



Ho.Re.Ca.



Health care



Car wash



Special applications

Steam cleaner

Boiler	Stainless-steel AISI 304 with interchangeable heating element	
Body	Varnished steel P04	
Power supply	V - Hz	1~ 230 - 50/60
Boiler output	kW/h	3,6
Maximum output	kW/h	3,65
Boiler volume	l	4
Operating pressure	bar	6
Water tank	l	3
Detergent tank	l	3
Steam production	g/min	97
	Kg/h	5,9
Steam temperature	° C	165

Vacuum cleaner

Power output	kW/h	1,2
Drum material	-	Plastic
Drum capacity	l	5,5
Air flow	m3/h	200
Depression	mm	2200

Various

Weight	Kg	33
Cable	m	8
Dimensions	cm	H.99 x L.40,8 x W. 69,7
Packaging	cm	60x45x75
Pallet/unit	pcs	4 8



Technical features



Operating pressure
6bar



Water tank



Detergent tank



Automatic water refilling



Power regulation switch



Detergent injection



Detergent regulation



Overheated water injection



Control panel



Vacuum cleaner



Boiler maintenance signal



Steam



Vacuum

Steam cleaners



Carmen Mini

kW 2,45

Applications



Ho.Re.Ca.



Health care



Household

Steam cleaner designed for semi-professional use with varnished-steel body and stainless-steel boiler able to deliver dry saturated steam at 165°C:

- Equipped with a wet&dry vacuum cleaner with a float or water filtration system.
- The ergonomic structure, the fully electric operation and the compact size allows its to usage in any environment.
- Equipped with hose holder, extension tubes holder, double accessories basket, cable holder, support bracket for Steam Mop and 360° swivel front wheels.

Steam cleaner

Boiler	Stainless-steel AISI 304 with interchangeable heating element	
Body	Varnished steel P04	
Power supply	V - Hz	1~ 230 - 50/60
Boiler output	kW/h	2,4
Maximum output	kW/h	2,45
Boiler volume	l	1,5
Operating pressure	bar	6
Water tank	l	2,5
Steam production	g/min	64
	Kg/h	3,8
Steam temperature	° C	165

Vacuum cleaner

Power output	kW/h	1,2
Drum material	-	Plastic
Drum capacity	l	5,5
Air flow	m3/h	200
Depression	mm	2200

Various

Weight	Kg	22
Cable	m	5
Dimensions	cm	H.99 x L.40,8 x W. 69,7
Packaging	cm	50x40x80
Pallet/unit	pcs	4 8



Chatanooga

Technical features



Operating pressure
6 bar



Water
tank



Overheated
water injection



Automatic
water refilling



Vacuum
cleaner



Steam



Vacuum

Baby Eco

kW 3,2

Applications



Ho.Re.Ca.



Household

Steam cleaner designed for domestic use with stainless-steel boiler able to deliver dry saturated steam at 158°C:

- Equipped with a wet&dry vacuum cleaner and a water filtration system.
- The main feature of this model is the possibility to separate the steam boiler and the vacuum cleaner and use them individually.
- Equipped with rubber bumper, cable holder and anti-scratch 360° swivel front wheels.
- The fully electric operation and its small size enable to use it in any environment.

Aida Baby



version with
stainless-steel body
[page 56](#)



Steam cleaner

Boiler	Stainless-steel AISI 304 with interchangeable heating element	
Body	PE - Varnished steel	
Power supply	V - Hz	1~ 230 - 50/60
Boiler output	kW/h	2
Maximum output	kW/h	3,2
Boiler volume	l	3
Operating pressure	bar	5
Water capacity	l	2
Steam production	g/min	55
	Kg/h	3,3
Steam temperature	° C	158

Vacuum cleaner

Power output	kW/h	1,2
Drum material	-	Plastic
Drum capacity	l	4
Air flow	m3/h	170
Depression	mm	1700

Various

Weight	Kg	19
Cable	m	5
Dimensions	cm	H.63 x L.33 x W. 35
Pallet dimensions	cm	40x80x50
Pallet/unit	pcs	12

Steam cleaner



Vacuum cleaner



Technical features



Operating pressure
5 bar



Vacuum cleaner with
water filtration system



Manual
boiler refilling



Steam

Gal

kW 2,45

Applications



Steam cleaner designed for professional use with ABS and varnished-steel body and stainless-steel boiler able to deliver dry saturated steam at 165°C or 174°C:

- Equipped with an overheated water injection system (available only for the 8-bar model).
- The ergonomic structure, the fully electric operation and the small size allows its to usage in any environment.
- All steam cleaner functions can be managed on the electronic control panel.
- Equipped with rubber bumper, cable holder and anti-scratch 360° swivel front wheels.

Steam cleaner

Boiler	Stainless-steel AISI 304 with interchangeable heating element	
Body	ABS VO - Varnished steel P04	
Power supply	V - Hz	1~ 230 - 50/60
Boiler output	kW/h	2,4
Maximum output	kW/h	2,45
Boiler volume	l	1,5
Operating pressure	bar	6 8
Water tank	l	3
Steam production	g/min	64
	Kg/h	3,8
Steam temperature	°C	165 174

Various

Weight	Kg	14
Cable	m	5
Dimensions	cm	H.33 x L.32 x W. 41
Packaging	cm	53 x 40 x 52
Pallet/unit	pcs	24



Chattanooga

Technical features



Operating pressure 8 bar



Operating pressure 6bar



Water tank



Automatic water refilling



Overheated water injection



Control panel



Boiler maintenance signal



Steam

Evo Blu Det

kW **2,45**

Steam cleaner designed for professional use with varnished-steel body and stainless-steel boiler, able to deliver dry saturated steam at 165°C:

- Detergent injection system.
- The ergonomic structure, the fully electric operation and the small size allows its to usage in any environment.
- All steam cleaner functions can be managed on the electronic control panel.
- Equipped with rubber bumper, cable holder and anti-scratch 360° swivel front wheels.

Applications

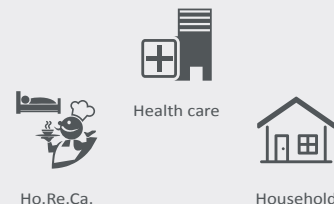

Steam cleaner

Boiler	Stainless-steel AISI 304 with interchangeable heating element	
Body	Varnished steel P04	
Power supply	V - Hz	1~ 230 - 50/60
Boiler output	kW/h	2,4
Maximum output	kW/h	2,45
Boiler volume	l	1,5
Operating pressure	bar	6
Water tank	l	3
Detergent tank	l	1
Steam production	g/min	64
	Kg/h	3,8
Steam temperature	° C	165

Various

Weight	Kg	14
Cable	m	5
Dimensions	cm	H.32,8 x L.28,9 x W. 43,8
Packaging	cm	53 x 40 x 52
Pallet/unit	pcs	24

Technical features



Operating pressure
6 bar



Water tank



Detergent tank



Automatic water refilling



Detergent injection



Control panel



Boiler maintenance signal



Steam

Evo Blu Water

kW 2,45

Applications



Ho.Re.Ca.



Health care



Household

Steam cleaner designed for professional use with varnished-steel body and stainless-steel boiler, able to deliver dry saturated steam 165°C:

- Overheated water injection.
- The ergonomic structure, the fully electric operation and the small size allows its usage in any environment.
- All steam cleaner functions can be managed on the electronic control panel.
- Equipped with rubber bumper, cable holder and anti-scratch 360° swivel front wheels.

Steam cleaner

Boiler	Stainless-steel AISI 304 with interchangeable heating element	
Body	Varnished steel P04	
Power supply	V - Hz	1~ 230 - 50/60
Boiler output	kW/h	2,4
Maximum output	kW/h	2,45
Boiler volume	l	1,5
Operating pressure	bar	6
Water tank	l	3
Steam production	g/min	64
	Kg/h	3,8
Steam temperature	° C	165

Various

Weight	Kg	14
Cable	m	5
Dimensions	cm	H.32,8 x L.28,9 x W. 43,8
Packaging	cm	53 x 40 x 52
Pallet/unit	pcs	24



Chattanooga

Technical features



Operating pressure
6 bar



Water
tank



Automatic
water refilling



Overheated
water
injection



Control
panel



Boiler
maintenance
signal



Steam

Evo Blu 24/7

kW 2,45

Steam cleaner designed for professional use with varnished-steel body and stainless-steel boiler able to deliver dry saturated steam 165°C:

- The ergonomic structure, the fully electric operation and the small size allows its to usage in any environment.
- All steam cleaner functions can be managed on the electronic control panel.
- Equipped with rubber bumper, cable holder and anti-scratch 360° swivel front wheels.

Applications

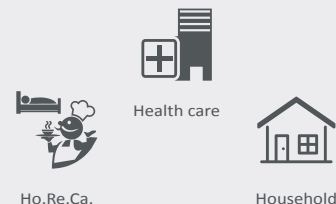

Ho.Re.Ca.

Health care

Household

Steam cleaner

Boiler	Stainless-steel AISI 304 with interchangeable heating element	
Body	Varnished steel P04	
Power supply	V - Hz	1~ 230 - 50/60
Boiler output	kW/h	2,4
Maximum output	kW/h	2,45
Boiler volume	l	1,5
Operating pressure	bar	6
Water tank	l	3
Steam production	g/min	64
	Kg/h	3,8
Steam temperature	° C	165

Various

Weight	Kg	14
Cable	m	5
Dimensions	cm	H.32,8 x L.28,9 x W. 43,8
Packaging	cm	53 x 40 x 52
Pallet/unit	pcs	24



Technical features



Operating pressure
6 bar



Water
tank



Automatic
water refilling



Control
panel



Boiler
maintenance
signal



Evo Blu Base

kW 2,4

Applications



Steam cleaner designed for semi-professional use with varnished-steel body and stainless-steel boiler, able to deliver dry saturated steam 165°C:

- The ergonomic structure, the fully electric operation and the small size allows its to usage in any environment.
- All steam cleaner functions can be managed on the electronic control panel.
- Equipped with rubber bumper, cable holder and anti-scratch 360° swivel front wheels.

Steam cleaner

Boiler	Stainless-steel AISI 304 with interchangeable heating element	
Body	Varnished steel P04	
Power supply	V - Hz	1~ 230 - 50/60
Boiler output	kW/h	2,4
Maximum output	kW/h	2,4
Boiler volume	l	4
Operating pressure	bar	6
Water capacity	l	3
Steam production	g/min	64
	Kg/h	3,8
Steam temperature	° C	165

Various

Weight	Kg	14
Cable	m	5
Dimensions	cm	H.32,8 x L.28,9 x W. 43,8
Packaging	cm	53 x 40 x 52
Pallet/unit	pcs	24



Chattanooga

Technical features



Operating pressure
6 bar



Manual
boiler refilling



Control
panel



Boiler
maintenance
signal



STEAM CLEANERS

Household range



Household



Steam



Vacuum

Aida Baby

kW 3,2

Steam cleaner designed for domestic use with stainless-steel boiler able to deliver dry saturated steam at 158°C:

- Equipped with a wet&dry vacuum cleaner and a water filtration system.
- The main feature of this model is the possibility to separate the steam boiler and the vacuum cleaner and use them individually.
- Equipped with rubber bumper, cable holder and anti-scratch 360° swivel front wheels.
- The fully electric operation and its small size enable to use it in any environment.

Applications



Ho.Re.Ca.



Household



Baby Eco



version with
varnished body
page 48

Steam cleaner

Boiler	Stainless-steel AISI 304 with interchangeable heating element	
Body	Upper: Stainless-steel AISI 304 BA Lower: Varnished steel	
Power supply	V - Hz	1~ 230 - 50/60
Boiler output	kW/h	2
Maximum output	kW/h	3,2
Boiler volume	l	3
Operating pressure	bar	5
Water capacity	l	2
Steam production	g/min	55
	Kg/h	3,3
Steam temperature	° C	158

Vacuum

Power output	kW/h	1,2
Drum material	-	Stainless-steel
Drum capacity	l	4
Air flow	m3/h	170
Depression	mm	1700

Various

Weight	Kg	19
Cable	m	5
Dimensions	cm	H.63 x L.33 x W. 35
Packaging	cm	40x40x80
Pallet/unit	pcs	12

Steam cleaner



Vacuum



Technical features



Operating pressure
5 bar



Vacuum cleaner with
water filtration system



Manual
boiler refilling



Steam

Tosca Evo

kW 2,45

Applications



Ho.Re.Ca.



Household

Steam cleaner with a varnished body and stainless-steel boiler, able to deliver dry saturated steam at 151° C:

- The ergonomic structure, the fully electric operation and their small size enable to use them in any domestic environment.
- Equipped with cable holder and anti-scratch 360° swivel front wheels.

Steam cleaner

Boiler	Stainless-steel AISI 304 with interchangeable heating element	
Body	Varnished steel P04	
Power supply	V - Hz	1~ 230 - 50/60
Boiler output	kW/h	2,4
Maximum output	kW/h	2,45
Boiler volume	l	4
Operating pressure	bar	4
Water capacity	l	3
Steam production	g/min	64
	Kg/h	3,8
Steam temperature	° C	151

Various

Weight	Kg	14
Cable	m	5
Dimensions	cm	32,8 x 28,9 x 43,8
Pallet/unit	pcs	24



Household

Technical features



Operating pressure
4 bar



Manual
boiler refilling



Steam

Elis

kW 1,5

Steam cleaner with a varnished/plastic body and stainless-steel boiler able to deliver dry saturated steam at 151° C:

- The ergonomic structure, the fully electric operation and their small size enable to use them in any domestic environment.
- Steam flow regulation.
- Equipped with cable holder and anti-scratch 360° swivel front wheels.

Applications



Ho. Re. Ca.



Household

Household



Steam cleaner

Boiler	Stainless-steel AISI 304 with interchangeable heating element	
Body	Lower: Varnished steel P04 Upper: Plastic	
Power supply	V - Hz	1~ 230 - 50/60
Boiler output	kW/h	1,5
Maximum output	kW/h	1,5
Boiler volume	l	4
Operating pressure	bar	4
Water capacity	l	3
Steam production	g/min	40
	Kg/h	2,5
Steam temperature	° C	151

Various

Weight	Kg	12
Cable	m	5
Dimensions	cm	30,8 x 41,7 x 25
Pallet/unit	pcs	24

Technical features



Operating pressure
4 bar



Manual
boiler refilling



Steam

Tresor Inox

kW 1,5 2

Applications



Ho.Re.Ca.



Household

Steam cleaners equipped with a stainless-steel boiler, able to deliver dry saturated steam at 142° C or 151° C:

- Tresor Inox can be used only with the already included professional iron.
- Tresor Inox 07: can be used with a professional iron as well as with various brushes, steam guns and other accessories.



INOX

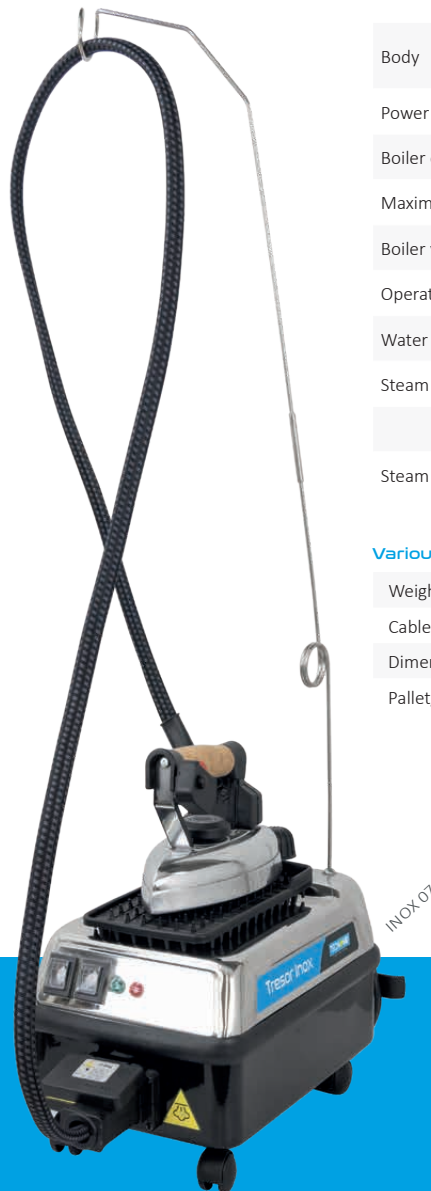

INOX 07

Steam cleaner

Modello	Tresor Inox	Tresor Inox 07
Boiler	Stainless-steel AISI 304 with interchangeable heating element	
Body	Upper: Stainless-steel AISI 304 Lower: Varnished steel P04	
Power supply	V - Hz	1~ 230 - 50/60
Boiler output	kW/h	1,5
Maximum output	kW/h	1,5
Boiler volume	l	2
Operating pressure	bar	3
Water capacity	l	1,5
Steam production	g/min	40
	Kg/h	2,5
Steam temperature	° C	142

Various

Weight	Kg	11
Cable	m	3
Dimensions	cm	25 x 25 x 40
Pallet/unit	pcs	24

Household

Technical features



Operating pressure
4 bar



Operating pressure
3 bar



Manual
boiler refilling



Suction



Blowing



Heating

Confort Free

Steam cleaner not included

Applications

- Professional ironing board with suction, blowing and heating functions.
- Support bracket for Tesor, Gal and Tosca models.



Ho.Re.Ca.



Household

Ironing board

Body		Chromed steel
Power supply	V - Hz	1~ 230 - 50/60
Power output	W	400
Suction/blowing fan	W	45
Adjustable height	cm	70 - 92
Board	cm	120x45
Height	cm	128
Shifting wheels	pcs	2
Max T° board	°C	58
Weight	Kg	20



Domestic tools

Professional irons



Professional iron
DUBLO



Professional iron
TULIPANO



Teflon base plate



Rubber rest pad

Vertical ironing



Steam gun with flat & round nozzle



Brush for vertical ironing
with brush



Superheating brush with microfiber
cloth for vertical ironing

Various



Vaporizer



HEPA filter



Refilling bottle 750ml



Microfiber cloth



STEAM CLEANERS

Bacchus range



Bacchus



Steam

Bacchus Static

kW 7,2 | 10,8 | 14,4

Steam cleaner with stainless-steel body and boiler, able to deliver dry saturated steam at 165°C.

- Water supply through water mains only.
- This model can be used only with the bacchus foodgrade silicone hose.

Winery production capacity



BOTTLING LINE
up to 3000^{PCS}/1h*



BARREL ROOM
up to 50 barrels*

*approx data



Bacchus

Steam cleaner

Boiler	Stainless-steel AISI 304 with interchangeable heating elements			
Body	Stainless-steel AISI 304 BA			
Power supply	V - Hz	3~ 400 - 50/60		
Boiler output	kW/h	7,2	10,8	14,4
Boiler volume	l	11		
Operating pressure	bar	6		
Steam production	g/min	194	272	388
	Kg/h	11,5	17,5	23
Steam temperature	° C	165		

Various

Weight	Kg	-
Cable	m	8
Dimensions	cm	H.107 x L.39,6 x W. 69,3
Pallet dimensions	cm	115x65x125
Pallet/unit	pcs	1

Technical features



Operating pressure
6 bar



Water mains
connection



Control
panel



Boiler
maintenance
signal



Steam

Bacchus Mini

kW 3,75

Winery production capacity

*approx data



BOTTLING LINE
up to 1500^{PCS}/1h*



BARREL ROOM
up to 20 barrels*

Steam cleaner with stainless-steel body and boiler, able to deliver dry saturated steam at 165°C.

- A sturdy structure, a fully electric operation and the compact size allows its usage in any environment, both outdoors (watertight protection IPX5) and indoors (e.g. in production lines).
- All steam cleaner functions can be managed on the electronic control panel.

Steam cleaner

Boiler	Stainless-steel AISI 304 with interchangeable heating element	
Body	Stainless-steel AISI 304 BA	
Power supply	V - Hz	1~ 230 - 50/60 3~ 400 - 50/60
Boiler output	kW/h	3,6
Maximum output	kW/h	3,75
Boiler volume	l	5
Operating pressure	bar	6
Serbatoi acqua	l	7,5 + 7,5
Steam production	g/min	97
	Kg/h	5,9
Steam temperature	° C	165

Various

Weight	Kg	30	
Cable	m	8	
Dimensions	cm	H.99 x L.41,3 x W. 66	
Packaging	cm	50x40x80	
Pallet/unit	pcs	4	8



Bacchus

Technical features



MyTecnovap connection



Operating pressure 6bar



Water mains connection



Double water tank



Automatic water refilling



Control panel



Boiler maintenance signal



Steam

Bacchus Pro

kW 3,75 7,35 10,95 14,55

Winery production capacity

Steam cleaner with stainless-steel body and boiler, able to deliver dry saturated steam at 165°C.

- A sturdy structure, a fully electric operation and the compact size allows its usage in any environment, both outdoors (watertight protection IPX5) and indoors (e.g. in production lines).
- All steam cleaner functions can be managed on the electronic control panel.



BOTTLING LINE
up to 3000^{pcs}/1h*



BARREL ROOM
up to 50 barrels*

*approx data



Bacchus

Steam cleaner

Boiler	Stainless-steel AISI 304 with interchangeable heating elements				
Body	Stainless-steel AISI 304 BA				
Power supply	V - Hz	3~ 400 - 50/60			
Boiler output	kW/h	3,6	7,2	10,8	14,4
Maximum output	kW/h	3,75	7,35	10,95	14,55
Boiler volume	l	7			
Operating pressure	bar	6			
Water tank	l	14			
Steam production	g/min	97	194	272	388
	Kg/h	5,9	11,6	16,3	23
Steam temperature	° C	165			

Various

Weight	Kg	60
Cable	m	8
Dimensions	cm	H.110 x L.53 x W. 82,5
Pallet dimensions	cm	115x65x125
Pallet/unit	pcs	1

Technical features



MyTecnovap
connection



Operating
pressure 6bar



Water mains
connection



Water
tank



Power
regulation
switch



Automatic
water
refilling



Control
panel



Boiler
maintenance
signal



Bacchus Industrial

kW 11 14,6 21,8 29 36,2

Winery production capacity

*approx data



BOTTLING LINE
up to 5000^{PCS}/1h*



BARREL ROOM
up to 50 barrels*

Steam cleaner with stainless-steel body and boiler, able to deliver dry saturated steam at 165°C.

- A sturdy structure, a fully electric operation and the compact size allows its usage in any environment, both outdoors (watertight protection IPX5) and indoors (e.g. in production lines).
- All steam cleaner functions can be managed on the electronic control panel.

Steam cleaner

Boiler	Stainless-steel AISI 304 with interchangeable heating elements					
Body	Stainless-steel AISI 304 BA					
Power supply	V - Hz	3~ 400 - 50/60				
Boiler output	kW/h	10,8	14,4	21,6	28,8	36
Maximum output	kW/h	11	14,6	21,8	29	36,2
Boiler volume	l	11	12	13		
Operating pressure	bar	6				
Water tank	l	20				
Steam production	g/min	291	388	582	776	970
	Kg/h	17,5	23	35	46,5	58
Steam temperature	° C	165				

Various

Weight	Kg	96 (mod.36kW)
Cable	m	8
Dimensions	cm	H.110 x L.53 x W. 82,5
Pallet dimensions	cm	115x65x125
Pallet/unit	pcs	1



Bacchus

Technical features



MyTecnovap connection



Operating pressure 6bar



Water mains connection



Water tank



Power regulation switch



Automatic water refilling



Control panel



Boiler maintenance signal



Steam



High pressure water

Steam Power

kW 14,8 18,4 21,2 21,6 32,8 40

Winery production capacity

Steam cleaner with stainless-steel body and boiler, designed for industrial use and able to deliver dry saturated steam at 183° C and high-pressure water up to 150 bar:

- A sturdy structure, a fully electric operation and the compact size allows its usage in any environment, both outdoors (watertight protection IPX5) and indoors (e.g. in production lines).
- All steam cleaner functions can be managed on the electronic control panel.
- Equipped with accessories basket, double hose holder, lance holder, cable holder and front 360° swivel wheels with safety brakes.



BOTTLING LINE
up to 5000^{PCS}/1h*



BARREL ROOM
up to 50 barrels*

*approx data



Steam cleaner

Boiler	Stainless-steel AISI 304 with interchangeable heating elements						
Body	Stainless-steel AISI 304 BA						
Power supply	V - Hz	3~ 400 - 50 (60Hz su richiesta)					
Boiler output	kW/h	10,8	14,4	18	21,6	28,8	36
Maximum output	kW/h	14,8	18,4	21,2	21,6	32,8	40
Boiler volume	l	13					
Operating pressure	bar	from 1 to 10					
Water tank	l	14					
Detergent tank	l	14					
Steam production	g/min	291	388	485	582	776	970
	Kg/h	17,5	23	29,1	35	46,5	58
Steam temperature	°C	up to 183					

High pressure water module

Motor output	kW/h	4
Water flow	l/min	13
Operating pressure	bar	from 0 to 150

Various

Weight	Kg	141
Cable	m	8
Dimensions	cm	H.102 x L.69 x W. 95,5
Pallet dimensions	cm	120x80x130
Pallet/unit	pcs	1

Technical features



MyTecnovap connection



Operating pressure 10 bar



Water pressure 150 bar



Water mains connection



Water & detergent tanks



Automatic water refilling



Detergent injection



Overheated water injection



Power regulation switch



Water pressure regulation



Water pressure regulation



Control panel



Boiler maintenance signal



Tools for barrels

To be used with Steam Power



Geysir 2 hose 10bar-150bar steam & water



800mm lance



1200mm lance



High pressure cleaning rod for barrels Ø730mm, with steam + vacuum + high pressure water

To be used with Bacchus models



Bacchus foodgrade silicone hose



Steam diffuser with thermometer for checking the actual temperature inside the barrel



High pressure cleaning rod for barrels Ø730mm, with steam + vacuum + high pressure water



High pressure water hose 10m



Extension for bigger barrels: suction tube for Ø940mm or Ø1070mm



Tools for bottling lines

Bacchus hose 4m - 8m - 10m



Bacchus foodgrade silicone hose



Bacchus foodgrade silicone hose
predisposed for pressure switch connection

Connector with a mechanical safety valve PED approved



GAROLLA



DIN



GAROLLA
with safety valve &
pressure switch



DIN
with safety valve &
pressure switch



Tools for general cleaning

July 6 bar



Hose
3m - 5m



Bayonette lance



45° curved bayonette lance



Steam lance



Triangular brush



Rectangular brush



Stainless-steel brush Ø28mm



Threaded stainless-steel
brush Ø28mm

July 10 bar



Hose
5m - 8m



Bayonette lance



45° curved bayonette lance



Steam lance



Triangular brush



Rectangular brush



Stainless-steel brush
Ø28mm



Threaded stainless-steel
brush Ø28mm

Geyser 110 bar



Hose
5m - 8m - 10m - 15m



100mm lance



800mm lance



400mm lance



1200mm lance



Flat nozzle
L. 10mm



Stainless-steel brush T50



STEAM CLEANERS

Special models



Special models

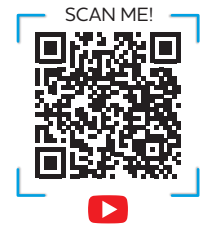

Car Hygiene Plus

kW 6,7

Applications



Car wash

Car Hygiene Plus is a cabinet specifically designed for the car wash sector:

- Available to be used in self-service mode or with operator.
- Equipped with a wet&dry vacuum cleaner with an induction turbine.
- Upon request, it is possible to provide CHP with a connection to the water supply.
- It comes with an internal PLC and timer.
- It is possible to set the duration of all requested available functions.
- Payment methods based on the local currency.
- Upon request, it is possible to equip CHP with a LED illumination system and a clock that automatically switches the LEDs on and off.



Special models

Steam cleaner

Boiler	Stainless-steel AISI 304 with interchangeable heating element	
Body	Stainless-steel AISI 304 BA	
Power supply	V - Hz	3~ N 400 - 50/60
Boiler output	kW/h	3,6
Maximum output	kW/h	6,7
Boiler volume	l	7
Stand-by consumption	kW/h	0,16
Operating pressure	bar	6
Water tank	l	20
Detergent tank	l	6
Steam production	g/min	97
	Kg/h	5,9
Steam temperature	° C	165

Vacuum cleaner

Power output	kW/h	3
Drum material	-	Stainless-steel AISI 304
Drum capacity	l	30
Air flow	m3/h	320
Depression	mm	3200

Various

Weight	Kg	215
Cable	m	8
Dimensions <i>accessory holders included</i>	cm	H. 164 x L. 117 x W. 75,1

Customizable stickers

The labels can be personalized according to customer's preferences.

Available payments methods



Banknotes



Coins



Token



Key or card



Credit card

Available functions

During the ordering process, it is possible to personalize the duration and cost of every function.



Steam + Vacuum

Star hose 8m and stainless-steel upholstery nozzle



Steam

July hose 8m and bayonette lance



Detergent

Detergent gun 7,5m



Vacuum

Vacuum hose 7,5m with plate nozzle



Compressed air

Inflating/deflating hose with pressure gauge

Possible configurations

A version with 2 functions

1. Steam + Vacuum

2. Steam

B version with 2 functions

1. Steam + Vacuum

2. Detergent

C version with 3 functions

1. Steam + Vacuum

2. Detergent

3. Vacuum

D version with 3 functions

1. Steam + Vacuum

2. Steam

3. Vacuum

E version with 3 functions

1. Steam + Vacuum

2. Detergent

3. Steam

F version with 4 functions

1. Steam + Vacuum

2. Detergent

3. Vacuum

4. Steam

G version with 4 functions

1. Steam + Vacuum

2. Detergent

3. Vacuum

4. Compressed air



Steam

Steam Sky

kW **40**

Steam cleaner with stainless-steel body and diesel-fired boiler able to deliver dry saturated steam at 183°:

- Water filtration system with automatic regeneration of the resins.
- It is used for environmentally friendly weeding or other applications where a connection to a power supply is not available.
- Designed to be used by two operators simultaneously thanks to the double steam connection.
- All steam cleaner functions can be managed on the electronic control panel.
- Equipped with hose holder, cable holder, forklift lifting brackets and safety brakes.

Applications



Car wash



Transport industry



Special applications



Ecological weed killing



Steam cleaner

Boiler	Stainless-steel AISI 316 L with interchangeable heating elements	
Body	Stainless-steel AISI 304 BA	
Power supply	V - Hz	1~ 230 - 50/60
Maximum output	Kcal/h	35.000
Boiler volume	l	10,7
Operating pressure	bar	10
Diesel consumption	l/h	4
Energy consumption	W	450
Water tank	l	35
Detergent tank	l	15
Diesel tank	l	18
Steam production	g/min	916
	Kg/h	55
Steam temperature	° C	183

Various

Weight	Kg	220
Cable	m	8
Dimensions	cm	H.107,9 x L.121,6 x W. 68,7
Pallet dimensions	cm	120x80x100
Pallet/unit	pcs	1



OPTIONAL:
Inverter for direct connection to a vehicle battery
12V DC 230V AC 1000W

Technical features



Operating pressure
10 bar



Two steam outlet



Water mains connection



Water tank



Detergent tank



Diesel tank



Automatic water refilling



Detergent injection



Overheated water injection



Control panel



Boiler maintenance signal



High-pressure washer



Hydrobox

kW 10,5 15,9

Applications



Food & Beverage



Mechanical industry



Transport industry



Wine cellars

Hot/cold high-pressure washer with stainless-steel body and boiler:

- The water temperature can be set from 20°C to 90°C.
- The water pressure can be set from 1 to 150bar.
- The ergonomic structure, the fully electric operation and the compact size allows its to usage in any environment.
- All steam cleaner functions can be managed on the electronic control panel.
- Equipped with hose holder, cable holder, lance holder and front 360° swivel wheels.

High-pressure washer

Boiler	Stainless-steel AISI 304 with interchangeable heating elements		
Body	Stainless-steel AISI 304 BA		
Power supply	V - Hz	3~ 400 - 50/60	
Boiler output	kW/h	9,0	14,4
Maximum output	kW/h	10,5	15,9
Boiler volume	l	5	
Operating pressure	bar	from 1 to 150	
Water flow	l/min	2	4
Water temperature	° C	from 20 to 90	

Various

Weight	Kg	57	
Cable	m	8	
Dimensions	cm	H.99 x L.66 x W. 40,8	
Packaging	cm	53 x 40 x 52	
Pallet/unit	pcs	8	

Accessories

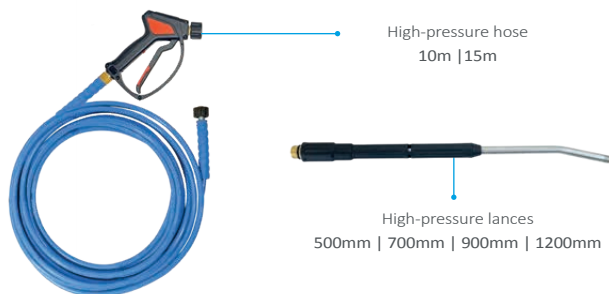

Special models

Technical features



Water mains connection



Water temperature regulation



Water pressure regulation



Control panel



Boiler maintenance signal



Steam

Evo Sanitizer

kW 2,45

Steam cleaner designed specifically for the healthcare sector, equipped with a stainless-steel boiler able to deliver dry saturated steam at 165° C:

- It allows to perform a thorough cleaning and sanitization of all critical surfaces within hospitals, aged care facilities, medical, dental and veterinary practices.
- Its ergonomic and compact structure makes it possible to access even narrow spaces.
- Equipped with cable holder and anti-scratch 360° swivel front wheels.

Applications



Ho.Re.Ca.



Health care



Steam cleaner

Boiler	Stainless-steel AISI 304 with interchangeable heating element	
Body	Varnished steel P04	
Power supply	V - Hz	1~ 230 - 50/60
Boiler output	kW/h	2,4
Maximum output	kW/h	2,45
Boiler volume	l	1,5
Operating pressure	bar	6
Water tank	l	3
Steam production	g/min	64
	Kg/h	3,8
Steam temperature	° C	165

Various

Weight	Kg	14
Cable	m	5
Dimensions	cm	H.32,6 x L.27,8 x W. 43,6
Packaging	cm	53 x 40 x 52
Pallet/unit	pcs	24

Technical features



Operating pressure
6 bar



Water tank



Automatic
water refilling



Control
panel



Boiler
maintenance
signal



Tosca Smart

kW 2,5

Applications



Household



Ho.Re.Ca.



Special applications

Steam cleaner with varnished-steel body and stainless-steel boiler able to deliver dry saturated steam at 151°C:

- Designed for vertical ironing and equipped with an integrated superheating brush.
- The ergonomic structure, the fully electric operation and the small size allows its to usage in any environment.
- Equipped with cable holder and anti-scratch 360° swivel front wheels.

Steam cleaner

Boiler	Stainless-steel AISI 304 with interchangeable heating element	
Body	Varnished steel P04	
Power supply	V - Hz	1~230 - 50/60
Boiler output	kW/h	2
Brush output	W	500
Maximum output	kW/h	2,5
Water capacity	l	3
Boiler volume	l	4
Operating pressure	bar	4
Steam production	g/min	55
	Kg/h	3,3
Steam temperature	° C	151

Various

Weight	Kg	14
Cable	m	5
Dimensions	cm	H.32,6 x L.27,8 x W. 43,6
Packaging	cm	53 x 40 x 52
Pallet/unit	pcs	24



Special models

Technical features



Operating pressure
4 bar



Manual
boiler refilling

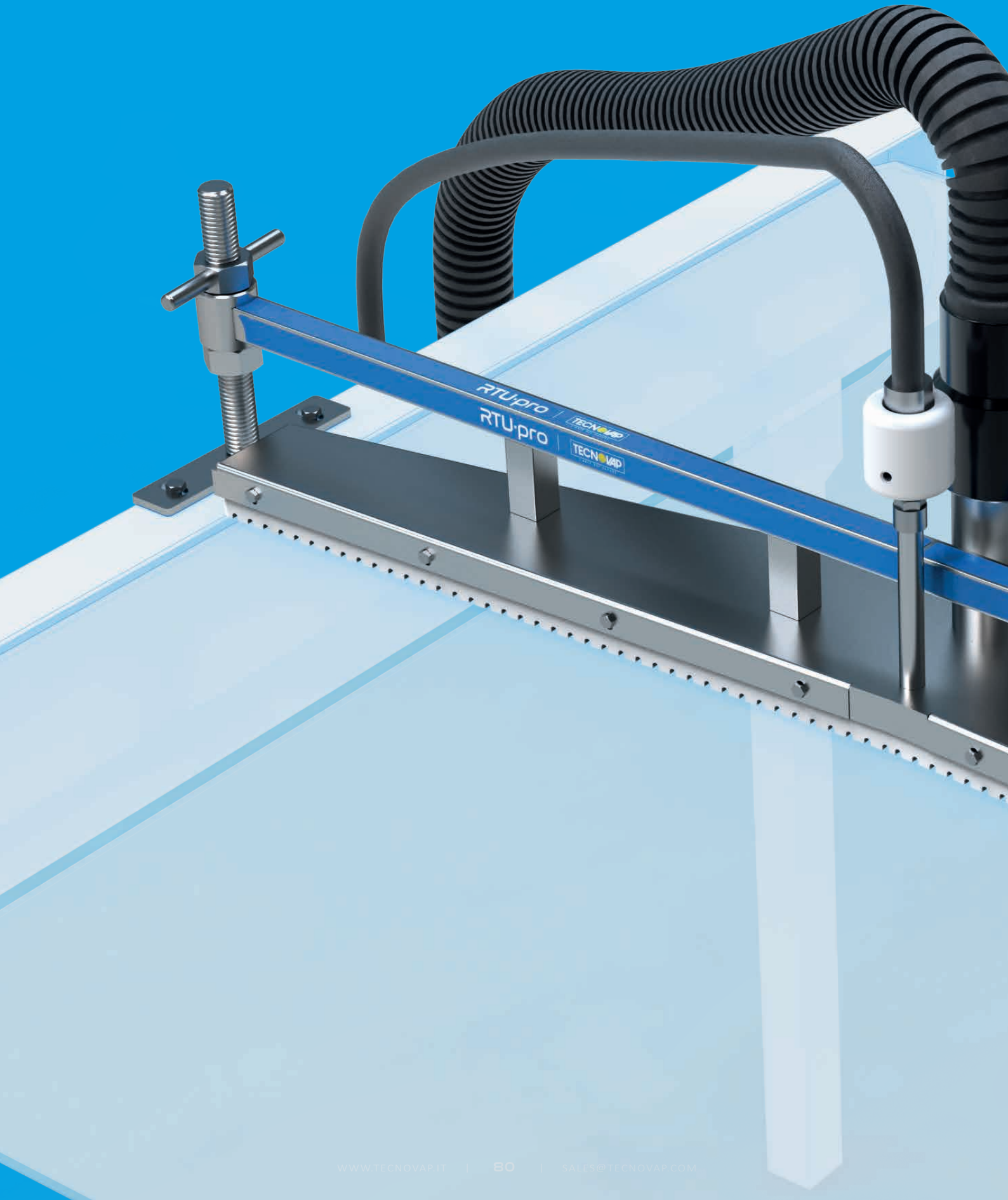

The power of dry saturated steam!

Our belt cleaning head is an eco-friendly and innovative product, designed to clean any kind of conveyor belt in a safe, efficient, and fast way.



Features



Customized for each customer.

AISI
304

Stainless-steel structure.



No risk of surface damage.
Programmed cleaning cycles help to extend the life of the belt.



Food-grade squeegees.



The system guarantees automatic cleaning and drying of the belt, unlike traditional manual cleaning methods.



When the tool is installed on the lower part of the conveyor structure, its usage is possible even during the production cycle.



Reduction of water consumption, saving of chemical products and less downtime of machines and production lines.

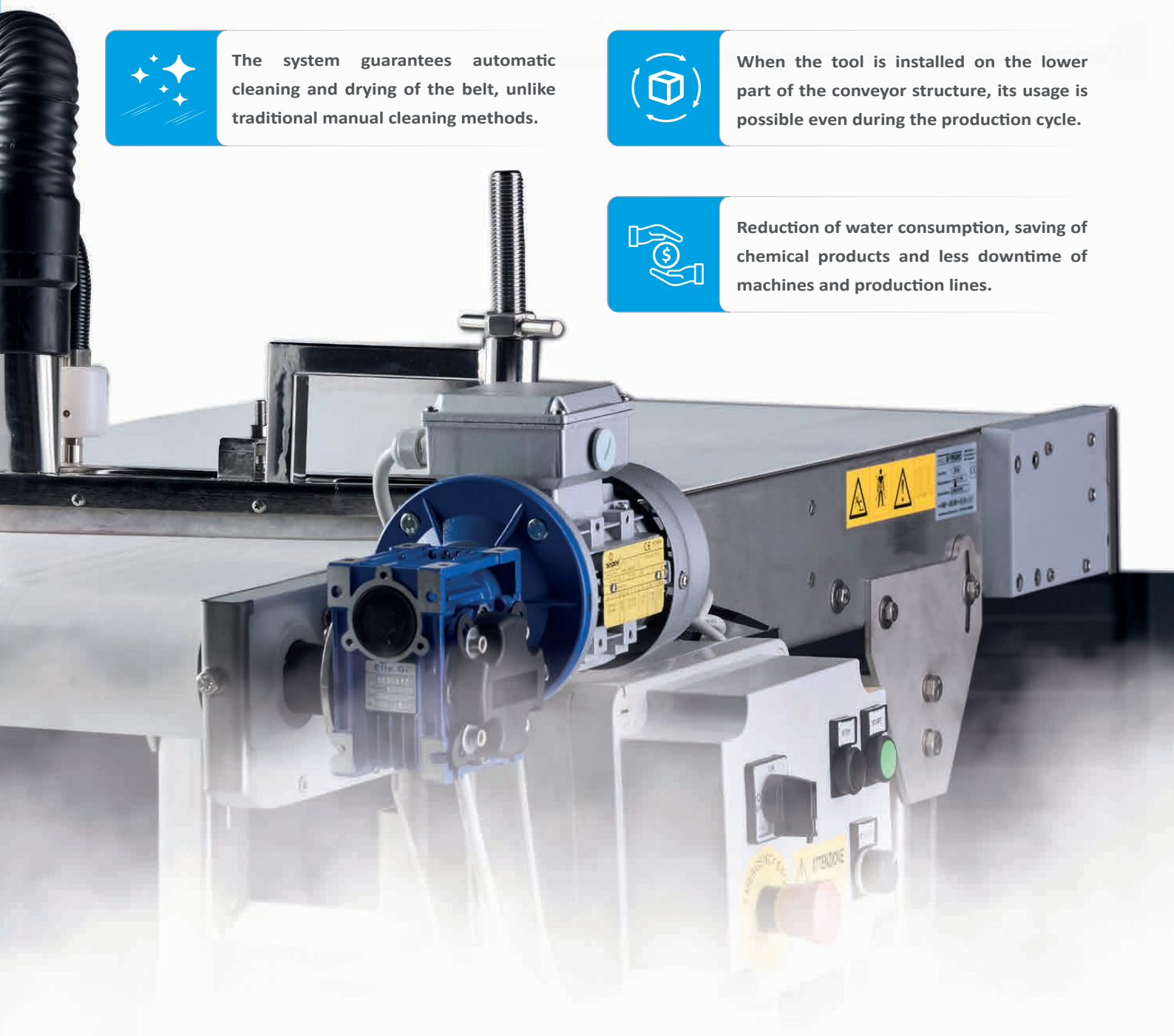



Rtu-Pro

Standard belt cleaning head

- AISI 304 stainless-steel structure
- The belt cleaning head is fixed to the conveyor belt structure by means of bolts with the possibility to adjust the tool by means of cranks
- Two possible installations on the lower or upper part of the belt
- Customizable dimensions up to 1500mm

Suitable for flat belts

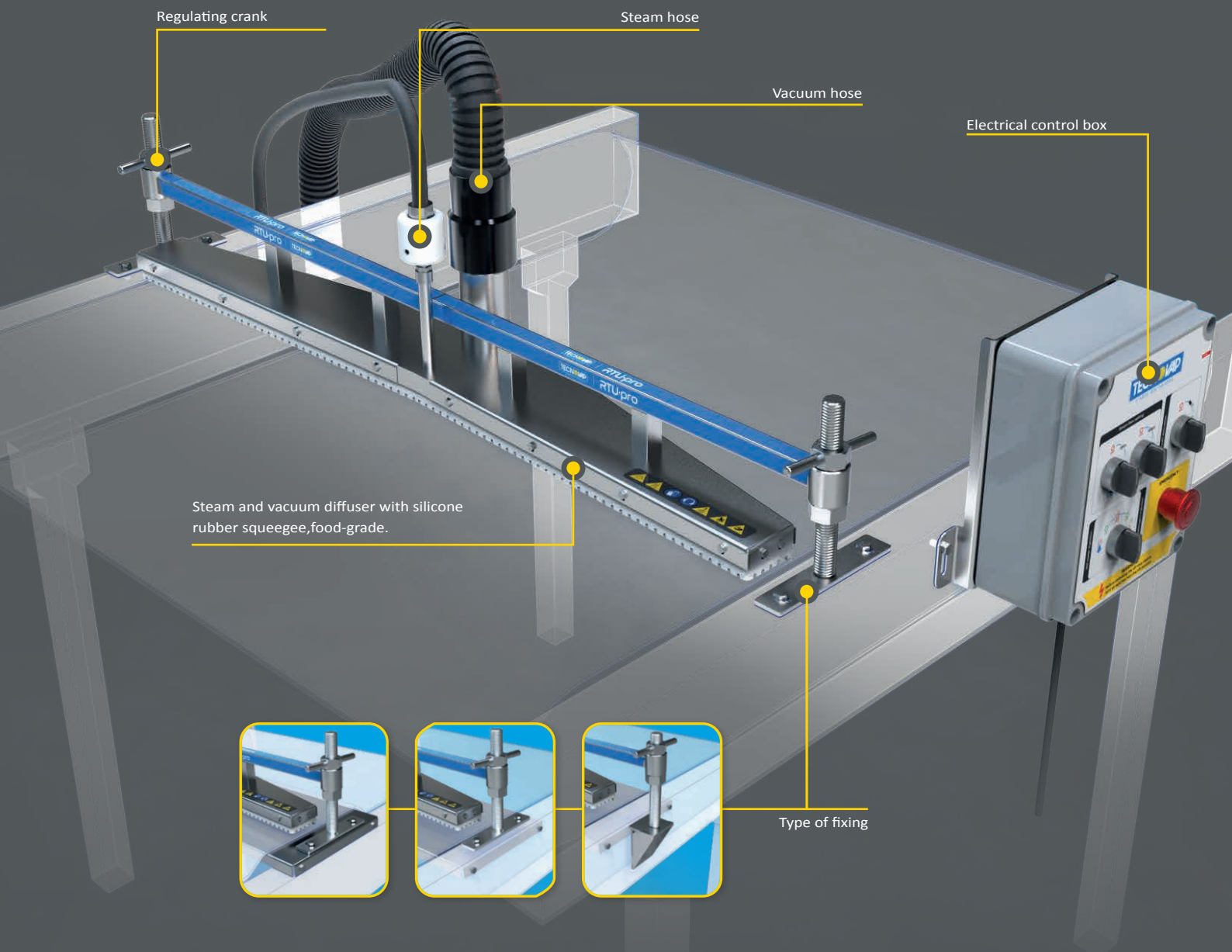
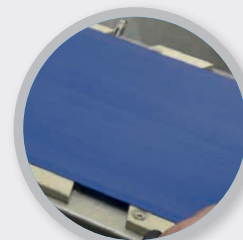

Regulating crank

Steam hose

Vacuum hose

Electrical control box

Steam and vacuum diffuser with silicone rubber squeegee, food-grade.

Type of fixing

Electrical control box

The belt cleaning tool is provided with an electrical control box for managing all functions of the steam generator and the belt cleaning head.

Steam flow control
MINIMUM - MEDIUM - MAXIMUM

Detergent injection activation
Overheated water injection activation



Vacuum activation

Emergency STOP button

Lower position

With this installation it is possible to clean the belt during the production cycle, therefore optimizing costs and cleaning times.



Special models

Rtu-Pro can be used with the following models:



Steam Plant
page:90



Steam Turbo
page:28



Steam Box Vac Industrial
page:29,30



Steam Box Vac Pro
page:32



HB·Max

Semi-automatic belt cleaning head

- AISI 304 stainless-steel structure
- Working and rest position adjustment of the cleaning head
- Installation exclusively on the lower part of the belt
- Customizable dimensions up to 1500mm

Suitable for mesh and flat belts

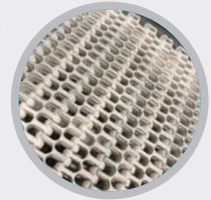
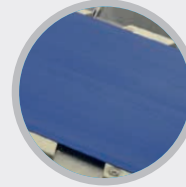

Steam and vacuum diffuser with silicone rubber squeegee, food-grade.

Electrical control box

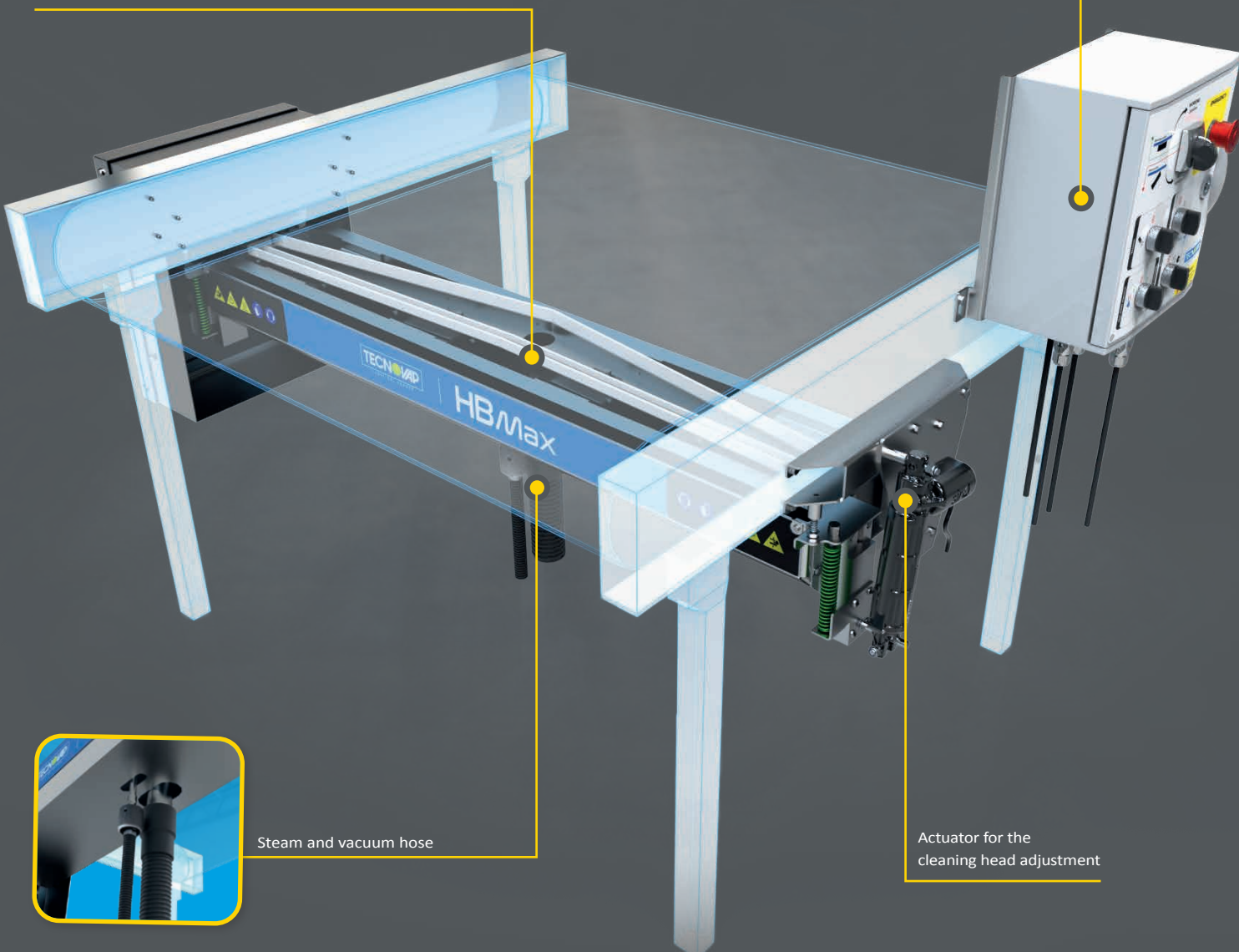

Steam and vacuum hose

Actuator for the cleaning head adjustment

Electrical control box

The belt cleaning tool is provided with an electrical control box for managing all functions of the steam generator and the belt cleaning head.

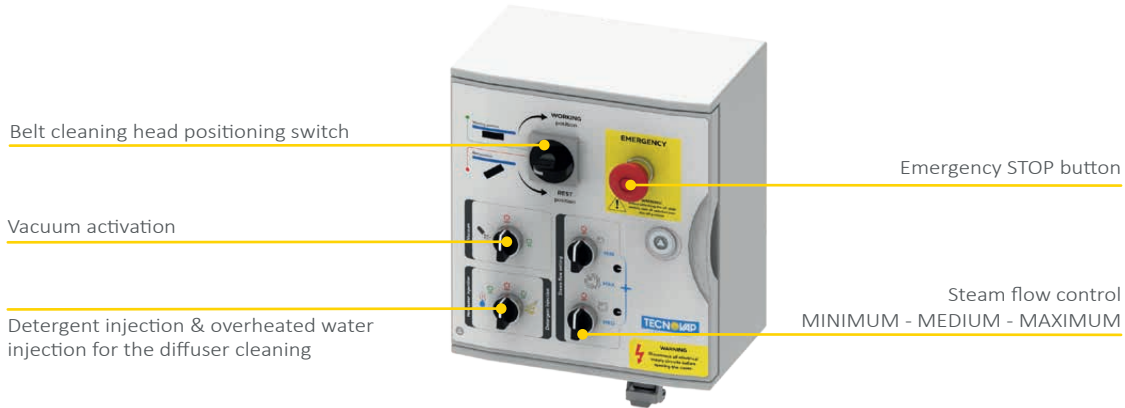

Lower position

With this installation it is possible to clean the belt during the production cycle, therefore optimizing costs and cleaning times.

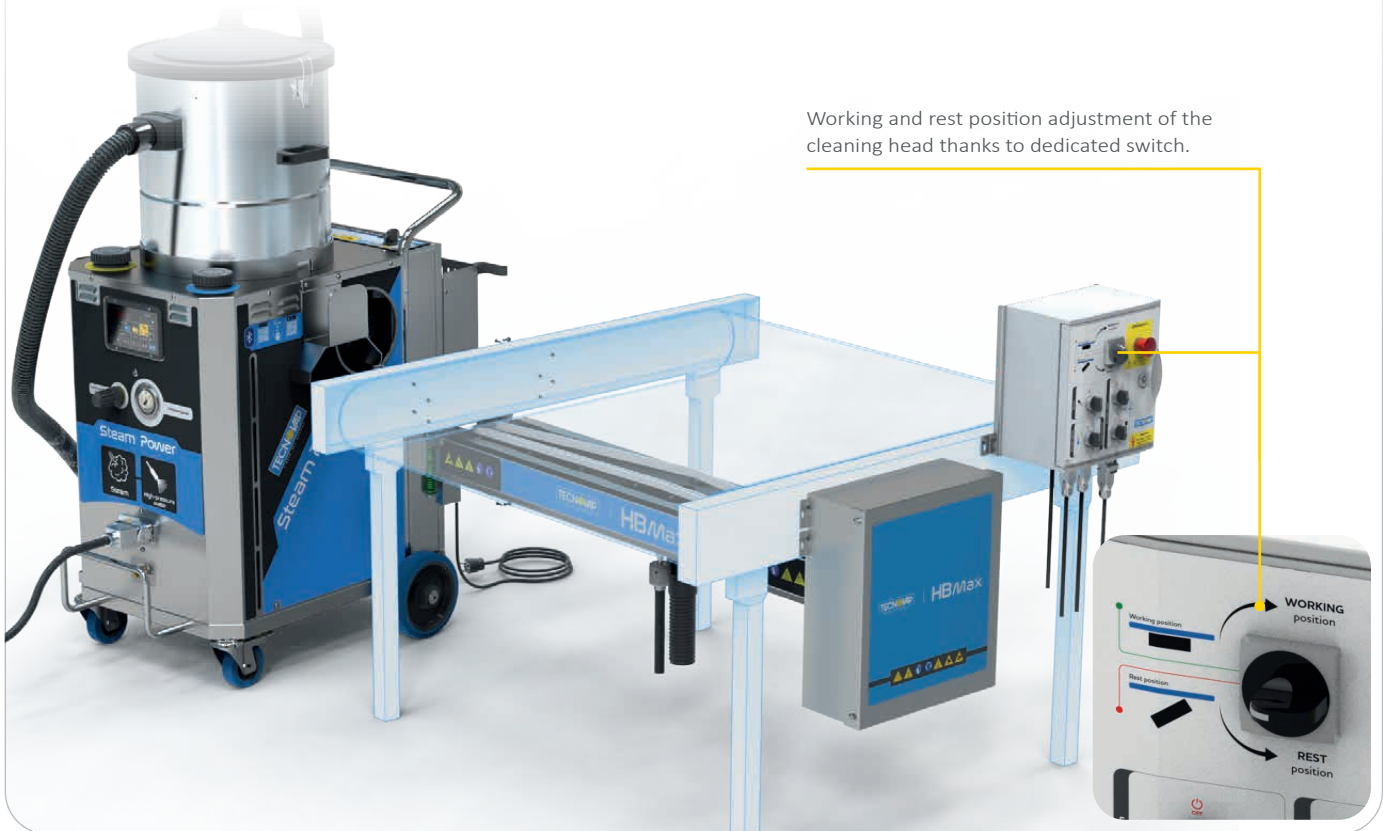

Special models

HB-Max can be used with the following models:





Lvc-Ultra

Automatic belt cleaning head with linear movement

- AISI 304 stainless-steel structure
- Programming of cleaning head working positions and working cycles
- Two possible installations on the lower or upper part of the belt
- Automatic movement of the steam diffuser
- Customizable dimensions up to 2000mm

Suitable for mesh belts

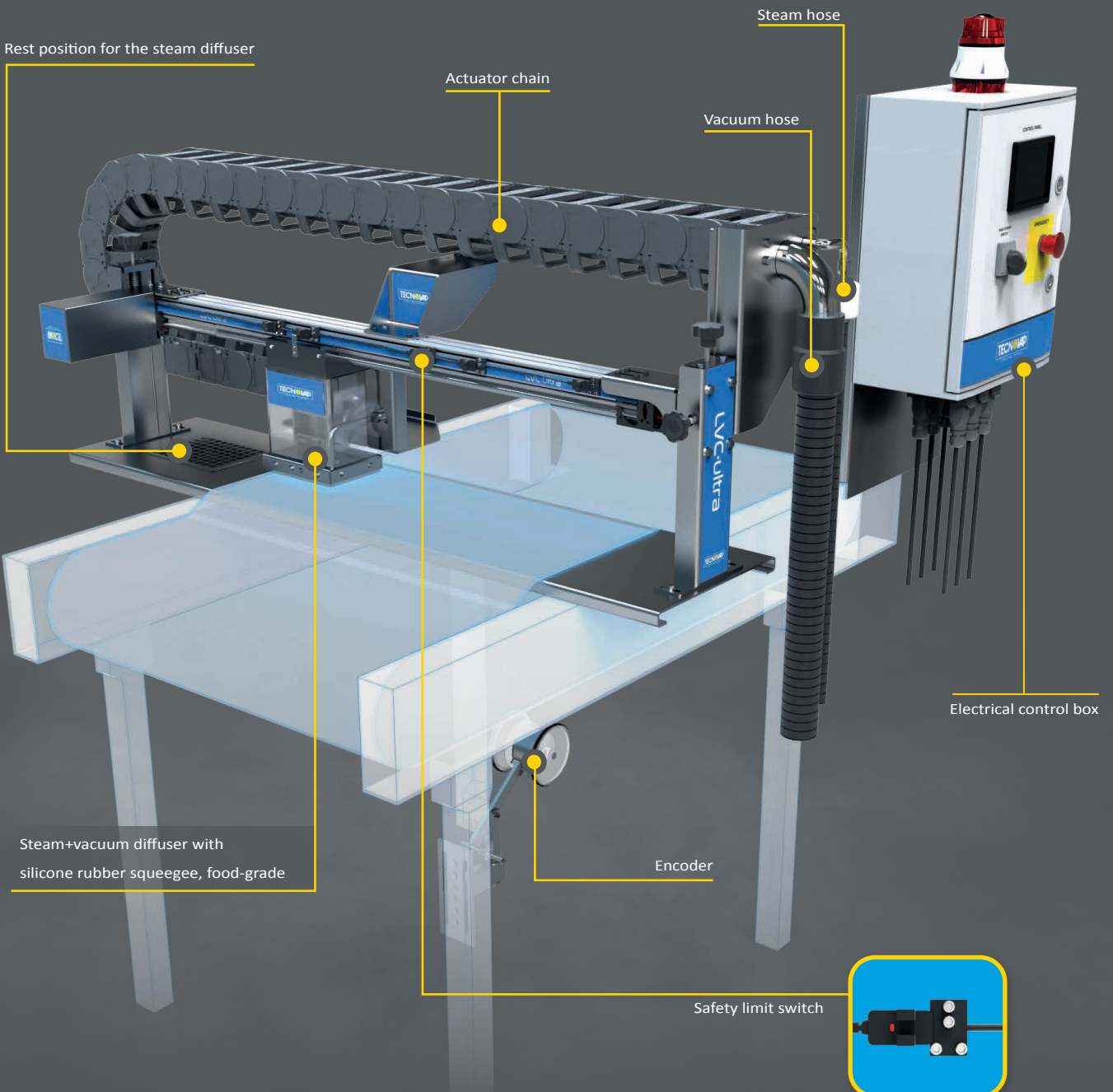
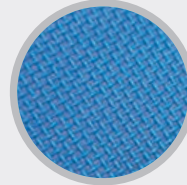

Electrical control box

The belt cleaning head is provided with an electrical control box with a touchscreen display for managing all functions of the steam generator and belt cleaning head.



Operating diagram

This type of belt cleaning tool offers the possibility to decide the position of the diffuser and to personalize the duration of the cleaning phase based on the belt.

With this installation it is possible to clean the belt during the production cycle, therefore optimizing costs and cleaning times.

1st position

Beginning of the cleaning cycle. The diffuser moves onto the 1st section of the belt.

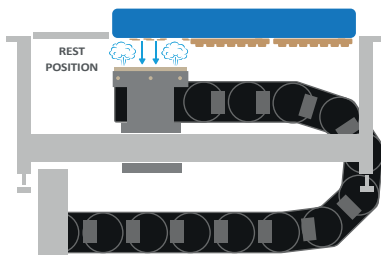

2nd position

Once the cleaning of the 1st section has been completed, the diffuser automatically moves onto the 2nd section.

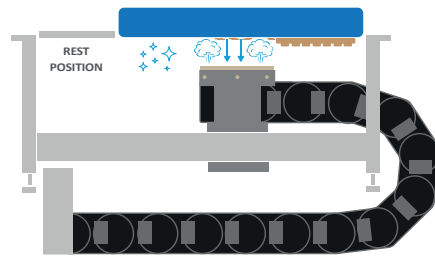

3rd position

Movements continue until the total width of the belt has been reached.

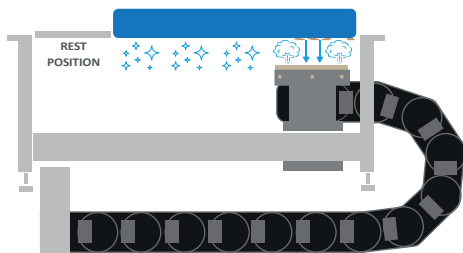

4th position

When the cleaning cycle is complete, the diffuser will automatically go back to the rest position.

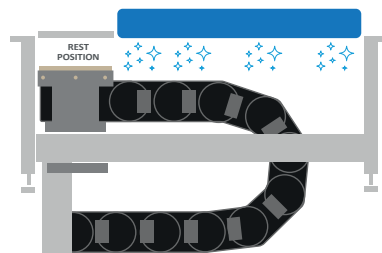

Lvc-Ultra can be used with the following models:





Steam



Vacuum

Steam Plant

Steam cleaner designed for the use in Food & Beverage industry.



Steam cleaner

Boiler	Stainless-steel AISI 304 with interchangeable heating elements	
Body	Stainless-steel AISI 304	
Power supply	V - Hz	3~ N 400 - 50/60
Boiler output	kW/h	from 10,8 to 36
Maximum output	kW/h	from 10,8 to 39,1
Boiler volume	l	11 - 12
Operating pressure	bar	6 10
Steam production	g/min	from 291 to 970
	Kg/h	from 17,5 to 58
Steam temperature	° C	165 183

Vacuum

Power output	kW/h	3
Drum capacity	l	30
Air flow	m3/h	320
Depression	mm	3200

Various

Weight	Kg	266
Cable	m	on request
Dimensions	cm	-
Pallet dimensions	cm	164 x 95 x 61
Pallet/unit	pcs	1



7" touchscreen panel

Technical features

- ✓ Automatic mains water feeding
- ✓ Integrated inflow water pressure reducer
- ✓ Integrated water treatment filter with cationic resins
- ✓ Cooling system for the vacuumed steam/liquid
- ✓ Completely automated discharge system for the vacuumed liquid
- ✓ Automatic boiler maintenance
- ✓ Anodizing treatment of the vacuum turbine for its protection against corrosion
- ✓ Automatic stop function
- ✓ Status signals on the light/acoustic indicator
- ✓ 7" touchscreen panel as HMI
- ✓ Simplified menu to start the cleaning, two buttons only: "Start" and "Stop"
- ✓ Cleaning time setting
- ✓ Failure diagnosis
- ✓ Multilingual menu

Tools for manual cleaning



Geyser 1 hose
Steam+vacuum



Radames 10bar hose
Steam+vacuum



Geyser lances

- 100mm
- 400mm
- 800mm
- 1200mm



Radames adapter for surface cleaner

Surface cleaners



Ø200mm with handle



Ø300mm with swivel & handle



Ø300mm with swivel



Example of surface cleaner with Radames adapter



PRODUCTS

Vacuum cleaners range





Vacuum

Vac Industrial

kW **3**

Wet&dry vacuum cleaner with an industrial turbine motor:

- Filtering system with cartridge filter and saturation state pressure gauge.
- Protected by a special cyclone for prevention against clogging.
- Equipped with a patented semi-automatic filter-shaker.
- Suitable for a continuous use even 24 hours per day.
- To be used with [Steam Box Industrial](#) & [Steam Box Pro](#).

Applications



Food & Beverage



Mechanical industry



Health care



Transport industry



Conveyor belts



Car wash



Vacuum cleaner

Drum material	Stainless-steel AISI 304	
Power supply	V - Hz	3~ 400 - 50/60
Power output	kW	3
Drum capacity	l	50
Air flow	m3/h	320
Depression	mm	3200
Noise level	db A	76
Protection	IP	55

Various

Weight	Kg	85
Cable	m	10
Pallet dimensions	cm	131x55x25
Pallet/unit	pcs	1

to be used with:
[Wet/Dry Industrial](#)
page 115





Vacuum

Vac Industrial ATEX

kW 2,2 2,6

Applications



Food & Beverage



Mechanical industry



Health care



Transport industry



Conveyor belts



Car wash

Wet&dry vacuum cleaner with an industrial turbine motor:

- Filtering system with cartridge filter and saturation state pressure gauge.
- ATEX certified.
- Protected by a special cyclone for prevention against clogging.
- Equipped with a patented semi-automatic filter-shaker.
- Suitable for a continuous use even 24 hours per day.
- To be used with [Steam Box Industrial](#) & [Steam Box Pro](#).

Vacuum cleaner

Drum material	Stainless-steel AISI 304		
Power supply	V - Hz	1~ 230 - 50/60	3~ 400 - 50/60
Power output	kW	2,2 - 2,6	
Drum capacity	l	50	
Air flow	m3/h	320	
Depression	mm	3200	
Noise level	db A	76	
Protection	IP	65	

Various

Weight	Kg	85
Cable	m	10
Pallet dimensions	cm	131x55x25
Pallet/unit	pcs	1

to be used with:
[Wet/Dry Industrial ATEX](#)
page 115





Vacuum

Vac Professional 2.0

kW **3,9**

Professional wet&dry vacuum cleaner with 3 motors:

- Equipped with three motors 1,3kW each.
- Stainless-steel drum with tilting trolley to facilitate emptying operations.
- Pre-filter for fine dust.
- Anti-foaming sponge filter.
- Plastic drum available on request.

Applications



Food & Beverage



Mechanical industry



Health care



Transport industry



Conveyor belts



Car wash



Vacuum cleaner

Drum material	Stainless-steel AISI 304	
Power supply	V - Hz	1~ 230 - 50/60
Power output	kW	1,3
Maximum output	kW	3,9
Drum capacity	l	78
Air flow	m3/h	650
Depression	mm	25
Noise level	db A	73

Various

Weight	Kg	24
Cable	m	10
Packaging	cm	101x55x65
Pallet/unit	pcs	1

to be used with:
[Wet/Dry Professional](#)
page 116





Vacuum

Vac 8 | Vac 14

kW 1,2

Applications



- Wet & dry vacuum cleaners with separator
- Water filtration system.
- Electric adjustment.
- Easy emptying of the vacuum drum.

Vacuum cleaner

Model	Vac 8		Vac 14
Drum material	Plastic		
Power supply	V - Hz	1~ 230 - 50/60	
Power output	kW	1,2	
Drum capacity	l	5	14
Air flow	m3/h	170	
Depression	mm	1700	



Various

Weight	Kg	8	9
Cable	m	5	
Packaging	cm	40x40x50	40x40x78
Pallet/unit	pcs	12	



to be used with:
Kit Dry
page 117





PRODUCTS

Tools





Geyser 1^{10bar}

Hose commands



Geyser 1 accessories can be used with the following models:



Steam Power
page:26,27



Steam Turbo
page:28



Steam Box Industrial
page:29-31



Steam Box Pro
page:32,33



Steam Box /Mini
page:34,35



Steam Tech
page:44



Steam Sky
page:76



Steam



High pressure water

Geyser 2 10bar - 150bar



Hose commands



Detergent injection



Overheated water injection



Steam control



High-pressure water control



800mm lance



Diffuser for lance



1200mm lance



Brush connection



Round nylon brush*
Ø35mm



Square nylon brush*
60x60mm



Rectangular nylon brush*
100x60mm



Round brass brush*
Ø35mm



Square brass brush*
60x60mm



Rectangular brass brush*
100x60mm



Round stainless-steel brush*
Ø35mm



Square stainless-steel brush*
60x60mm



Rectangular stainless-steel brush*
100x60mm

*utilizable with Geyser 1 lances

Geyser 2 accessories can be used with the following models:



Steam Power Plus
page:27



Steam Power
page:26



Steam



Vacuum

Radames 10bar

Hose commands



*depending on the purchased model, the commands may vary



Hose
4m - 8m - 12m

Standard kit

Extension tubes - 2pcs
L. 480mm

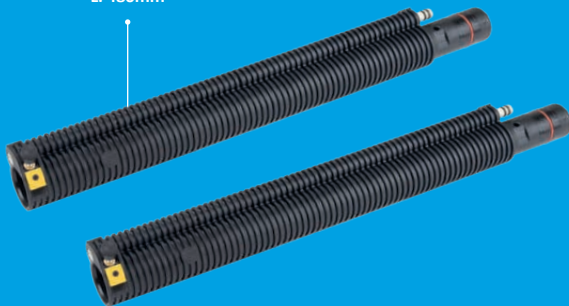

Floor tool
L. 375mm



Squeegee/squeegee insert L. 375mm

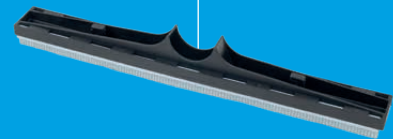

Brush/squeegee insert - 2pcs
L. 375mm





Stainless-steel upholstery tool



Steam+vacuum industrial brush
L. 530mm



Steam+vacuum turbo lance



Brass brush
L. 80mm



Stainless-steel insert
L. 375mm



Stainless-steel brush
Ø60mm



Stainless-steel brush
L. 80mm



Brass brush
Ø28mm



Stainless-steel brush
Ø28mm



Steel wool pad

Radames 10bar accessories can be used with the following models:



Steam Power Plus
page:27



Steam Turbo
page:28



Steam Box Vac Industrial
page:29,30



Steam Box Vac Pro
page:32



Steam Box Vac /Mini
page:34



Steam Tech
page:44



Steam



Vacuum

Star 10bar

Hose commands

Steam indicators



Min

Med

Max



Steam control button



Vacuum indicator



Vacuum button



Steam ready indicator



Detergent injection button



Detergent indicator*
(blinking = low detergent)



Overheated water indicator*
(blinking = low water)



Overheated water injection button

*depending on the purchased model, the commands may vary



Hose
4m - 8m - 12m

7P plug

for 6bar steam cleaners



Standard kit

Star/Radames adapter



Extension tubes - 2pcs
L. 480mm

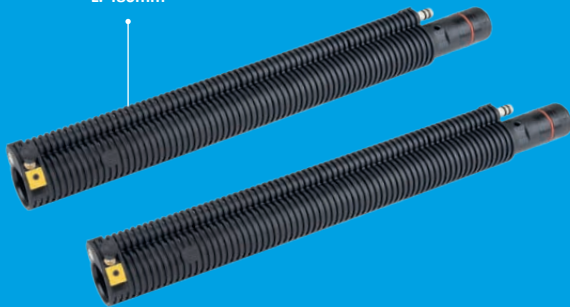

Floor tool
L. 375mm



Squeegee/squeegee insert
L. 375mm

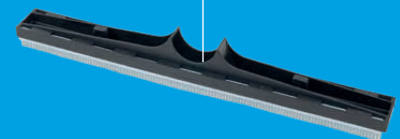

Brush/squeegee insert - 2pcs
L. 375mm





Stainless-steel upholstery tool



Steam+vacuum industrial brush
L. 530mm



Steam+vacuum turbo lance



Long steam lance



Steam lance



Brass brush
L. 80mm



Stainless-steel brush
L. 80mm



Brass brush
Ø28mm



Stainless-steel brush
Ø28mm



Stainless-steel brush
Ø60mm



Steel wool pad



Triangular nylon brush



Nylon brush
Ø28mm



Stainless-steel brush T50

Star 10bar accessories can be used with the following models:



Steam Power Plus
page:27



Steam Turbo
page:28



Steam Box Vac Industrial
page:29,30



Steam Box Vac Pro
page:32



Steam Box Vac Mini
page:34



Junior Star Max
page:45



Steam Tech
page:44



July 10bar

Hose commands



*depending on the purchased model, the commands may vary

Standard kit

Extension tubes - 2pcs
L. 480mm

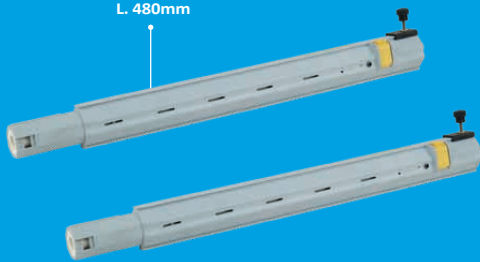

Rectangular brush



Triangular brush



Steam lance



Stainless-steel brush
Ø28mm



Brass brush
Ø28mm



Stainless-steel brush
Ø60mm



Steel wool pad





Bayonette lance



45° curved bayonette lance



Round nylon brush
Ø35mm



Rectangular nylon brush
100x60mm



Square nylon brush
60x60mm



Round brass brush
Ø35mm



Rectangular brass brush
100x60mm

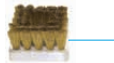

Square brass brush
60x60mm



Round stainless-steel brush
Ø35mm



Rectangular stainless-steel brush
100x60mm



Square stainless-steel brush
60x60mm

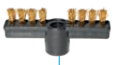

Threaded brass brush
L. 80mm



Threaded stainless-steel brush
L. 80mm



Threaded brass brush
Ø28mm



Stainless-steel brush T50



Threaded stainless-steel brush
Ø28mm

July 10bar accessories can be used with the following models:





Steam



Vacuum

Radames 6bar

Hose commands



*depending on the purchased model, the commands may vary



Standard kit

Extension tubes - 2pcs
L. 480mm



Floor tool
L.375mm



Squeegee/squeegee insert
L.375mm

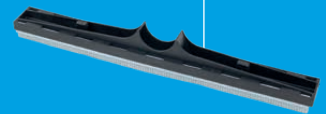

Squeegee/brush insert
L.375mm



Steam+vacuum turbo lance



Stainless-steel brush
Ø28mm



Nylon brush
Ø28mm



Brass brush
Ø28mm



Nylon brush
Ø60mm



Steam scraper



Triangular nylon brush
Ø28mm



Steam plunger
Ø60mm



Steel wool pad



Radames→Star adapter



Star→Radames adapter



Extension tube L. 80mm



Stainless-steel upholstery tool



Steam+vacuum window cleaner



Transparent carpet tool



Vacuum lance



Vacuum nozzle



Cloth for window cleaner



Stainless-steel insert
L. 145mm



Squeegee/brush insert
L. 145mm



Squeegee/squeegee insert
L. 145mm



Carpet insert
L. 145mm



Stainless-steel insert
L. 375mm



Brass brush
L. 80mm



Stainless-steel brush
L. 80mm



Nylon brush
L. 80mm



Horse hair brush
Ø28mm



Horse hair brush
Ø60mm



Stainless-steel brush
Ø60mm

Radames 6bar accessories can be used with the following models:

S.B. Vac /Mini
page:34

Carmen Plus
page:36,46

Carmen /Mini
page:37,47

Steam Tech
page:44

Junior Star /Max
page:45

Baby models
page:48,56



Steam



Vacuum

Star 6bar

Hose commands

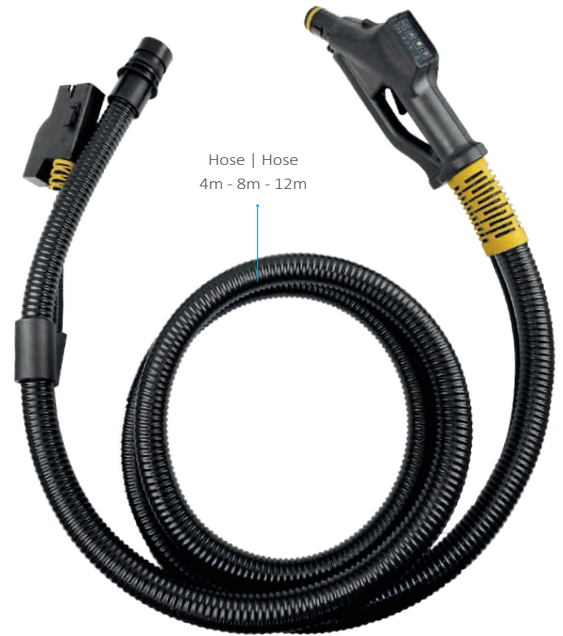

*depending on the purchased model, the commands may vary

Standard kit

Extension tubes - 2pcs
L. 480mm



Floor tool
L. 300mm

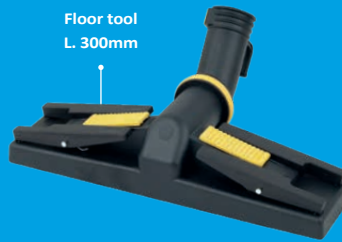

Squeegee/squeegee insert
L. 300mm

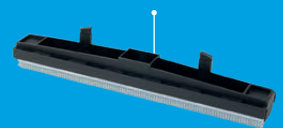

Window cleaner



Vacuum nozzle



Steam lance



Carpet insert
L. 300mm

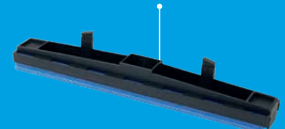

Floor tool
L. 145mm



Squeegee/squeegee insert
L. 145mm

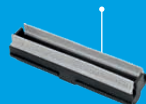

Brush/brush insert
L. 145mm

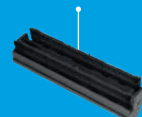

Brush/brush insert
L. 300mm



Nylon brush
Ø28mm





Stainless-steel upholstery tool



Long steam lance



Threaded stainless-steel brush
Ø28mm



Threaded nylon brush
Ø28mm



Threaded triangular nylon brush
Ø28mm



Threaded brass brush
Ø28mm



Stainless-steel insert
L.375mm



Squeegee/brush insert
L. 145mm



Radames to Star adapter



Star to Radames adapter



Brass brush
L. 80mm



Stainless-steel brush
L. 80mm



Nylon brush
L. 80mm



Horse hair brush
Ø28mm



Horse hair brush
Ø60mm



Stainless-steel brush
Ø60mm



Triangular nylon brush
Ø28mm



Brass brush
Ø28mm



Stainless-steel brush
Ø28mm



Nylon brush
Ø60mm



Steam plunger



Nylon brush
Ø28mm



Steam scraper



Steel wool pad

Star 6bar accessories can be used with the following models:



S.B. Vac Mini
page:34



Carmen Plus
page:36,46



Carmen Mini
page:37,47



Steam Tech
page:44



Junior Star Max
page:45



Baby models
page:48,56



Steam

July 6bar

Hose commands



*depending on the purchased model, the commands may vary



Standard kit

Extension tubes - 2pcs
L. 480mm



Rectangular brush



Triangular brush



Window cleaner



Steam lance



Stainless-steel brush
Ø28mm



Nylon brush
Ø28mm



Brass brush
Ø28mm



Nylon brush
Ø60mm



Steam scraper



Triangular nylon brush
Ø28mm



Steam plunger
Ø60mm

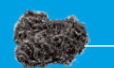

Steel wool pad



Steam lance (red)

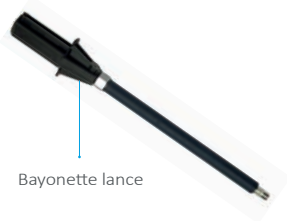

Bayonette lance



45° curved bayonette lance



Threaded brushes Ø28: Nylon - Brass - Stainless-steel



Extension tube
L. 290mm



Memory lance



Memory lance tissue cover



Mop with queegee
L. 220mm



Movable mop
L. 220mm



Movable mop
L. 400mm



Mop
L. 220mm



Steam plunger
Ø120mm



Stainless-steel brush
Ø60mm



Nylon brush
L. 80mm



Brass brush
L. 80mm



Stainless-steel brush
L. 80mm



Horse hair brush
Ø28mm



Horse hair brush
Ø60mm



Nylon brush (red)
Ø28mm



Steam scraper



Microfiber cloth
L. 220mm



Cotton/polyester cloth
L. 220mm



Triangular steam buffer



Rectangular steam buffer



Triangular microfiber bonnet



Rectangular microfiber bonnet

July 6bar accessories can be used with the following models:



S.B. Mini
page:35



Carmen models
page:36,37,46,47



Steam Tech
page:44



Junior Star Max
page:45



Evo models
page:38-41,50-53,78



Gal/Tosca
page:49,57,58



Tresor Inox 07
page:59



Baby models
page:48,56



Steam Mop

6 bar

Hose commands

- Ergonomic handle with safety lever
- Switches for steam flow regulation: MIN - MED - MAX



Tested by the University of Verona



Rubber bumper

Microfiber cloth L. 400mm



Cotton/polyester cloth L. 400mm



Ultra-microfiber cloth L.400mm
for glass and steel surfaces

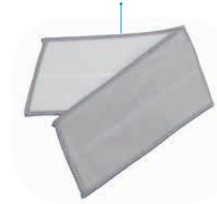

Telescopic pole +50cm

Steam hose 5m - 10m
available with or without
detergent injection

Steam Mop can be used with following models:



S.B. Mini
page:35



Carmen models
page:36,37,46,47



Steam Tech
page:44



Junior Star/Max
page:45



Evo models
page:38-41,50-53,78



Gal/Tosca
page:49,57,58



Tresor Inox 07
page:59



Baby models
page:48,56



Vacuum

Tools



Wet/Dry Industrial

Available ATEX version.



Vacuum hose PVC Ø50mm
5m



Double elbow tube



Flat chromed steel nozzle
Ø50mm



Floor tool for dust



Floor tool for liquids



Sucker nozzle
Ø50mm



Flat nozzle
Ø50mm



Round dust brush
Ø50mm

OPTIONAL



90° curved conic lance



Conic tool

Wet/Dry Industrial accessories can be used with the following models:



Vac Industrial ATEX
page:94



Vac Industrial
page:95



Wet/Dry Professional



Vacuum hose PVC Ø40mm
5m



Double elbow tube



Floor tool with squeegee insert



Floor tool with brush insert



Round dust brush



Flat plastic nozzle

OPTIONAL



Net accessories



Pre-filter for fine dust



Nylon filter

Wet/Dry Professional accessories can be used with the following model:



Vac Professional 2.0
page:96



Vacuum

Tools



Dry



Vacuum hose
PVC Ø50mm
5m



Extension tubes



Upholstery nozzle



Velvet insert



Floor tool



Flat plastic nozzle



Round dust brush in horsehair

OPTIONAL



Vacuum floor tool



Squeegee insert
(liquids)



Brush insert
(dust)



Telescopic lance

Dry accessories can be used with the following models:



Vac 14
page:97



Vac 8
page:97



Special tools





Steam



Vacuum

T.e.s.s. 10bar

TECNOVAP EXTREME STEAM SYSTEM

A new system designed to drive hygiene standards higher than ever thought possible. Safety, efficiency, ROI, everything in one system, designed for a single user.

This innovative cleaning method for **high-level surfaces** opens up a whole new market of jobs, services and income streams to all types of businesses, from one-man operations to the largest multinationals. The system allows the operator to **safely and efficiently clean walls, ceilings and all surfaces in any area, above or underneath fixed machinery and plant, removing the need for specialist equipment such as scissor lifts.** This creates a new “best practice” for all industry and manufacturers worldwide. The system delivers **dry steam at high temperature** to the surface, whilst vacuuming away the moisture. It requires a much smaller operational footprint than traditional methods and **can be operated during production.**

Applications



Light-weight carbon fibre poles.
Safety interlock system.

Up to
10m
in height

Initial pole with control panel
L.950 mm

Steam Indicators



Vacuum indicator and button



Steam ready indicator



Detergent button and indicator*
(blinking = low detergent)



Overheated water button and indicator*
(blinking = low water)

Tools

Why choose T.e.s.s.?

- ✓ Removing the need for specialist equipment such as scissor lifts.
- ✓ Cleaning of walls, windows, ceilings and every high-level surface
- ✓ Can be operated during production without any downtime.
- ✓ Creating a safer and cleaner environment for all stakeholders.
- ✓ Cleaning high-level surfaces opens up a whole new market of jobs

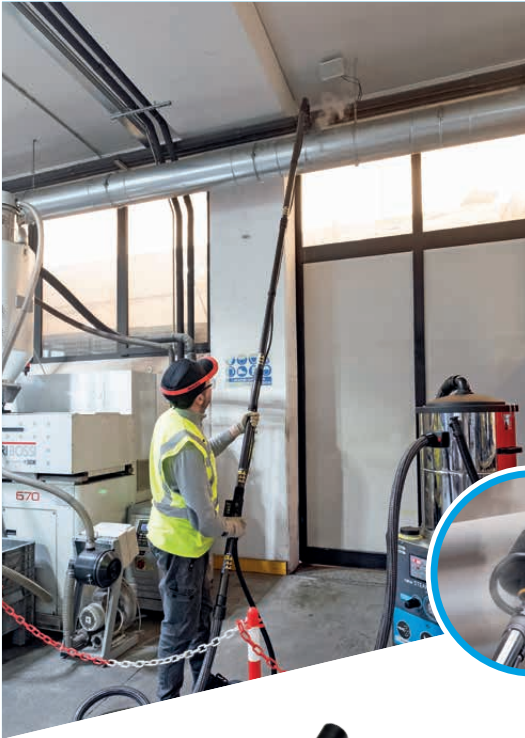

Additional pole L.1250 mm



Straight carbon fiber connector



45° curved carbon fiber connector



90° curved carbon fiber connector



Steam+vacuum triangular brush
** Possibility of using various Star accessories or, with a special adapter, Radames accessories*

Accessory bag



T.e.s.s. can be used with the following models:



Steam Turbo Brush 6bar - 8 bar

The only Wet & Dry multifunctional steam scrubber.



Steam Turbo Brush is provided with:

- MICROFIBER ROLLER:**
Gently and thoroughly washes all hard surfaces, even parquet. The rollers do not leave lint, have a high absorbing power and are very durable.
- BRUSHED ROLLER:**
Made with high-quality bristles for perfect results when cleaning carpets and rugs.
- LITHIUM BATTERY:**
Studied to provide extra power during high performance jobs. Resists the memory effect and self-discharge. The 3-level battery status can be viewed on a LED display.
- QUICK CHARGER:**
Ergonomic housing and versatile positioning, easily placeable on walls. Intelligent battery management and fast charging system with 6-level indicator.

Technical data

Average autonomy at minimum speed	h	2
Average autonomy at maximum speed	min	40
Maximum output	W	100
Battery	V	18 - 3A
Suction width	mm	310
Weight (with battery)	Kg	2,75
Dimensions	mm	355 x 290 x 95

SCAN ME!



4 different speed settings



Battery compartment

Microfiber roller

Brushed roller

V-shape roller

Battery and battery charger

Steam Turbo Brush can be used with the following models:



Steam Box Vac /Mini
page:34



Carmen Plus
page:36,46



Carmen Mini
page:37,47



Steam Tech
page:44



Junior Star Max
page:45



Superheated gun Steam-X



**Bed-bug
extermination system**



Laboratory
tested system



**Tecnovap's steam cleaners represent
the ideal solution to fight the presence of these insects**



EFFECTIVENESS:

Steam at high temperature is lethal to bedbugs and their eggs, ensuring their complete and permanent elimination.



ECOLOGY:

Unlike chemical pesticides, steam is completely eco-friendly and does not release harmful residues in environment after its usage.



VERSATILITY:

Steam generators can be used on a variety of surfaces, from mattresses to sofas, without risking to damage their fabrics.



PREVENTION:

Regular usage of steam helps to prevent the appearance of new bed bugs, while keeping the environment safe and clean.



Steam-X can be used with the following models:





Special accessories

Car wash tools - 6bar / 10bar



Radames
Stainless-steel upholstery tool



Star
Stainless-steel upholstery tool



Radames/Star
Trasparent upholstery tool



Radames/Star
Steam/vac nozzle with
nylon or horse hair bristles



July 6bar
Curved bayonette lance 60mm



July 10bar
Curved bayonette lance 60mm

Steam+vacuum lances 6bar / 10bar



Radames
Steam+vacuum lance
with vacuum nozzle L. 80mm



Star
Steam+vacuum lance



Special accessories



Radames 10bar

Steam/vacuum floor tool with 3 strips
1 black nylon bristles + 1 squeegee blade + red squeegee blade



Radames 10bar

Steam/vacuum floor tool with 3 strips
2 squeegee + 1 white nylon brush



Star 6bar - 10bar
Steam/vacuum floor tool
L. 230mm



Radames 10bar
Floor tool L. 140mm 10 bar
with white nylon bristles



Star 6bar - 10bar
Floor tool L.105mm



Radames 10bar
Floor tool L. 145mm
with squeegee insert



Radames/Star 6bar - 10bar
Window cleaner
L.150mm / L. 250mm



Radames/Star 6bar - 10bar
Window cleaner L.250mm with mop

Special accessories



Mop L. 90mm
6 - 10 bar



Movable mop L. 220mm
10 bar



Movable mop L. 400mm
10 bar



Mop L. 230mm 90° bent
6 bar



Mop Ø100mm for pipes
6 bar



Mop Ø130mm for pipes
6 bar



Geyser 1
Movable mop L. 400mm

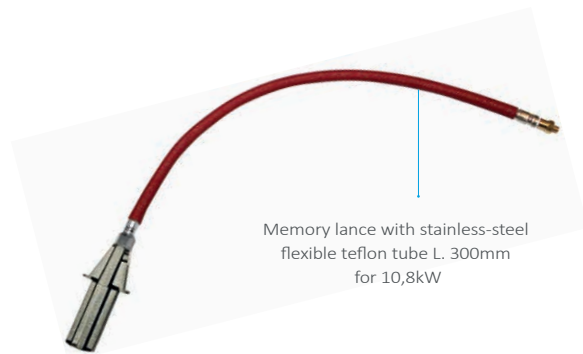

Memory lance with stainless-steel
flexible teflon tube L. 300mm
for 10,8kW



Memory lance with copper tube
10 bar



Memory lance with stainless-steel flexible tube
10 bar



Special accessories

Chewing-gum removal



Vapo Gum 5 L



Radames/Star
Chewing-gum tool with floor nozzle



Carpet nozzle



Stainless-steel brush T50



Threaded triangular brush
Ø28mm



Threaded nylon brush
Ø28mm

Various



July 6bar
Pipe cleaner



Nylon brush - blue
Ø28mm



Nylon brush - yellow
Ø28mm



Nylon brush - green
Ø28mm



Nylon brush - red
Ø28mm

Detergents



Vapo Clean
Vapo Food
5 liters

Nebulizer tool



July 6bar
Bottle 0,5l / 1l



Special accessories

Ecological weed control tools



L. 400x400mm - L. 400x800mm - L. 1200x1100mm

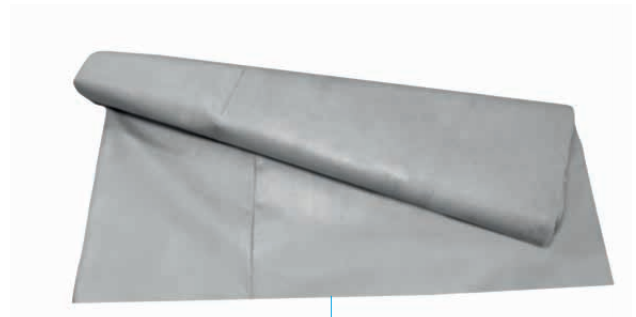

L. 1500mmx2800mm



Rectangular weed killer hood



Round weed killer hood

Water treatment

Water softner



Water softener cartridge with resins
for consumption up to 800 liters



Water softener with automatic regeneration of resins through sodium chlorite
for consumption above 800 liters

Kit for installation on the steam cleaner

suitable for **Steam Box, Steam Power & Bacchus**



Water depuration kit
external water purifying filter + stainless-steel holder



Water softener kit
water softener cartridge with resins* + liter counter + stainless-steel holders
for consumption up to 800 liters



Steam applications



Steam



Steam+Vacuum

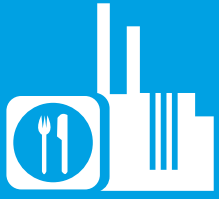

STEAM APPLICATIONS

Food & Beverage



Butcheries, bakeries, dairies, food laboratories and many other possibilities!



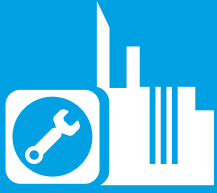

STEAM APPLICATIONS

Mechanical industry



With steam you have unlimited possibilities in the mechanical industry!



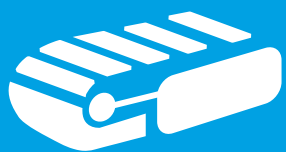

STEAM APPLICATIONS

Conveyor belts



For flat and mesh conveyor belts!

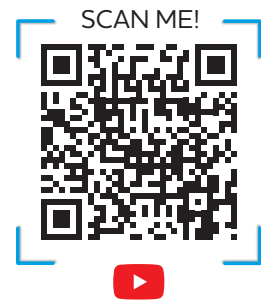
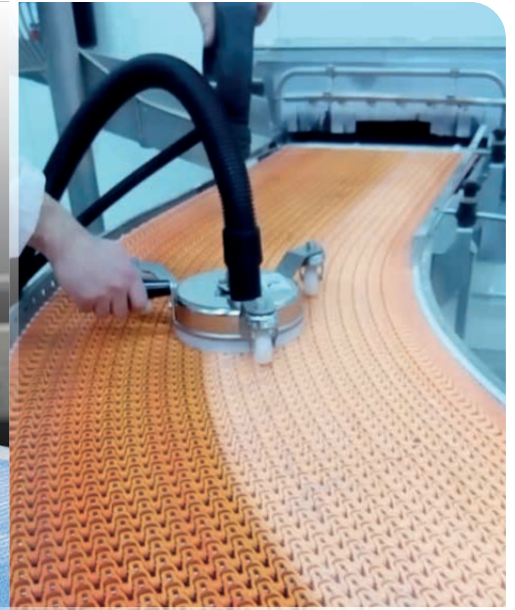



STEAM APPLICATIONS

Transport industry



Means of transport such as trains, buses and cruise ships!

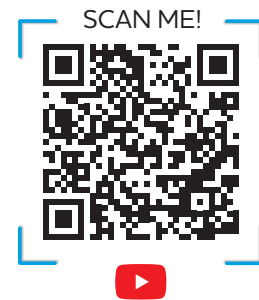
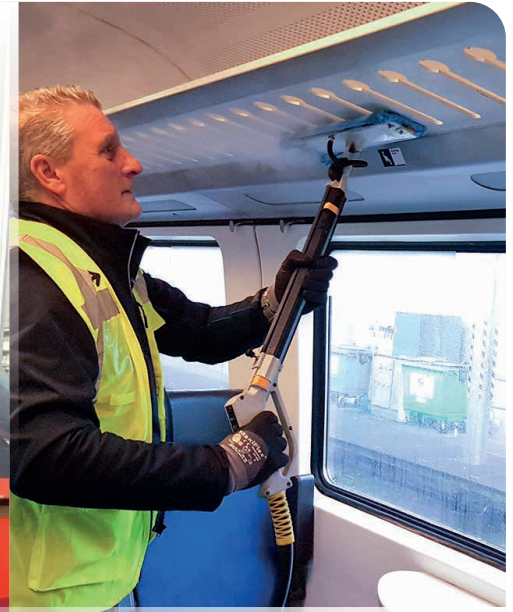



STEAM APPLICATIONS
Ho.Re.Ca.



Hotels, restaurants, professional kitchens, fitness centers and beauty farms!

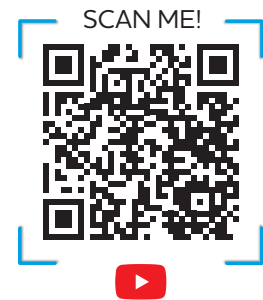



STEAM APPLICATIONS

Healthcare



Operating rooms, medical clinics, waiting rooms and medical vehicles!

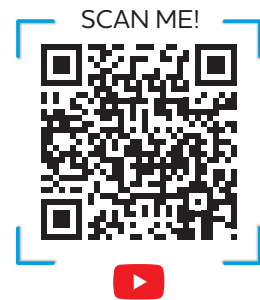
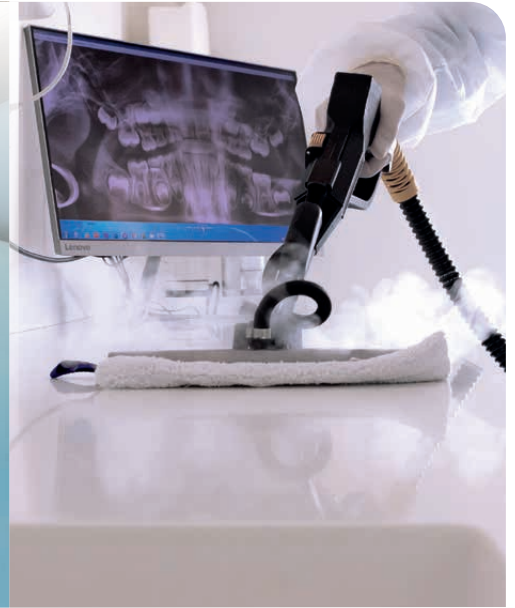



STEAM APPLICATIONS

Car wash



Interior and exterior cleaning of vehicles!





STEAM APPLICATIONS

Wine cellars



Barrels, steel tanks and bottling lines!

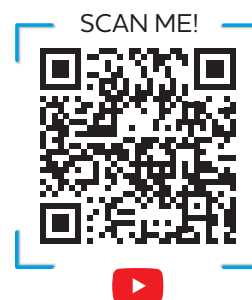



STEAM APPLICATIONS
Household



Kitchens, bathrooms, living rooms and upholstery!

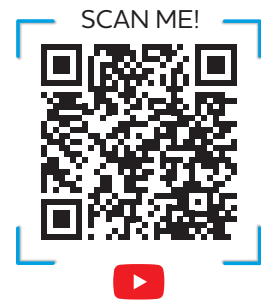

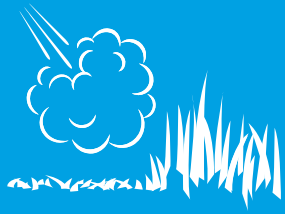

STEAM APPLICATIONS

Ecological weed killing



Public areas, squares and monuments!





STEAM APPLICATIONS

Special applications



For sport courts, chewing gum removal and much more!



Contacts

Tecnovap S.r.l.

Via dei Sassi 1/a, 37026 Pescantina, Verona - Italy

+39 045 67 67 252 - sales@tecnovap.com - info@tecnovap.com - www.tecnovap.it



SCAN ME!

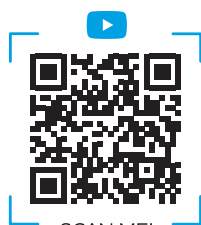

SCAN ME!



SCAN ME!



Steam is the best ally on the market, it is effective and ecological.

Choose the future of cleaning,
choose Tecnovap!





Tecnovap S.r.l. - Via dei Sassi 1/a, 37026 Pescantina, Verona - Italia
+39 045 67 67 252 - sales@tecnovap.com - www.tecnovap.it